

Pro846

USER'S GUIDE

8

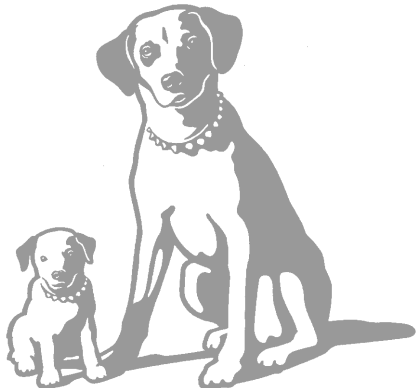

PRO8

PRO8[®] CAMCORDER

Important Safety Information

Be sure to read all the safety information before you begin to use this product.

WARNING: To reduce the risk of fire or shock hazard, do not expose camcorder or AC adapter/charger to rain or moisture.

CAUTION

RISK OF ELECTRIC SHOCK
DO NOT OPEN



This symbol indicates “dangerous voltage” inside the product that presents a risk of electric shock or personal injury.

ATTENTION

RISQUE DE CHOC
ELECTRIQUE NE PAS OUVRIR



This symbol indicates important instructions accompanying the product.

TO REDUCE THE RISK OF ELECTRIC SHOCK, DO NOT REMOVE THE COVER (OR BACK). NO USER-SERVICEABLE PARTS ARE INSIDE. REFER SERVICING TO QUALIFIED SERVICE PERSONNEL.

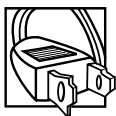

CAUTION: To prevent electric shock, match wide blade of plug to wide slot, fully insert.

ATTENTION: Pour éviter les chocs électriques, introduire la lame la plus large de la fiche dans la borne correspondante de la prise et pousser jusqu'au fond.

To reduce risk of injury, charge only rechargeable batteries recommended by the manufacturer for this camcorder. Other types of batteries may burst causing damage and personal injury.

CAUTION: Avoid operating your camcorder immediately after moving it from a cold location to a warm location. Give the camcorder 1-1/2 to 2 hours to reach a stable temperature before inserting a video cassette. When moved from a cold area to a warm location, moisture may condense on the head drum inside the machine. This moisture could cause the tape to stick to the headwheel and damage the headwheel or tape.

FCC Regulations state that unauthorized changes or modifications to this equipment may void the user's authority to operate it.

Product Registration

Please fill out the product registration card and return it immediately. Returning this card allows us to contact you if needed.

Keep your sales receipt for proof of purchase to obtain warranty parts and service and attach it here. Record the serial and model numbers located on the bottom of the camcorder.

Model Pro846

Serial No: _____

Purchase Date: _____

Purchased From: _____

Assistance

We want to make sure you enjoy your new camcorder. If you have any questions, call:

Camcorder Exchange Warranty..... 800-283-6503 (Pages 66-67)

Customer Service..... 800-336-1900 (Page 65)

Accessories..... 800-338-0376 (Pages 55-61)

Table of Contents

Safety Informationi	• Install Remote Battery9
	• Remote Sensor9
Product Registrationi	• Location and Function of Remote Buttons10-11
Contents1-2	
First-Time Operation	Powering Your Camcorder
• Assistance.....3	• Using the Adapter/Charger12
• Unpack Camcorder and Accessories3	• Using the Rechargeable Battery
• Attach the Adapter/Charger4	• Charging and Refreshing13
• Insert a Cassette4	• Inserting and Removing14
• Attach the Lens Cap Cord and Adjust the Handstrap.....5	• Care and Storage15
• Turn on the Camcorder5	• Safety Precautions15
• Adjust Eyepiece Focus Control.....6	• Using Alkaline Batteries
• Start and Stop Recording6	• Inserting.....16
• Play Back What You Have Recorded7	• Safety Precautions17
• Review the Camcorder's Operating Controls7-8	• Battery Level Indicator17
	• Using the Optional Car Cord Adapter.....18
	• Using the Optional Car Cord Adapter/Charger.....19
Remote Control	

Table of Contents

Video Cassettes

- Erase Protection20
- Recording and Playback Speed and Times.....20
- Inserting and Removing Cassettes.....21
- Cassette Care and Storage.....21

Recording Features

- Microphone22
- Flying Erase Head.....22
- Tally Light.....22
- Quick Review.....22
- Edit Search23
- Tape Positioning23
- Time Remaining Display24
- Program AE (Auto Exposure).....24
- Date Search25
- Date and Time Display
 - Set the Date and Time26
 - Record the Date and Time, Date, or Date and Title.....27
 - Install the Clock Lithium Cell.....28
- Viewfinder
 - Eyepiece Focus Control29
 - *COLOR, TINT, and BRIGHT* Controls.....29
 - Tilt Adjustment29
- Displays in Viewfinder30-31
- Focusing
 - Auto Focus32
 - Manual Focus33
 - Macro Focus33
- Zooming34
- Time Counter with Memory Stop35
- Titler
 - Creating a Title.....36
 - Recording Titles37
- Audio/Video Dubbing38-39

- Synchro Edit40-41
- Recording from VCR or TV Monitor.....42-43

Optional Color Enhancement

- **Light**.....44-45

Attaching the Shoulder Strap46

Removing the Lens Hood46

Recording and Traveling Tips47

Playback

- Viewfinder Playback.....48
- Playback Features
 - Stop-Action Pause49
 - Visual Searching49
- Playback on TV (or VCR) with *AUDIO/VIDEO IN* Jacks50-51
- Playback on TV without Audio and Video Inputs.....52-53

Care and Maintenance54

Optional Accessories.....55-61

- Accessory Order Form.....59-61

Trouble Checks62-63

Specifications64

User Information.....64

Assistance.....65

Limited Warranty.....66-67

Index (Alphabetical).....68-69

First-Time Operation

This section describes only the basic steps necessary to set up your camcorder to record. Refer to the other sections for detailed operation and feature options.

Assistance

The toll-free numbers are available to help you with any problem you may encounter.

- Camcorder Exchange Warranty800-283-6503
- Customer Service800-336-1900
- Accessories800-338-0376

1. Unpack the camcorder and accessories.

- Save the packing materials and box in case you ever need to ship or store your camcorder.
- The items shown below are packed with your camcorder. If any are missing or appear damaged, contact your dealer immediately.

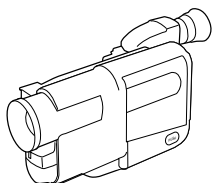

Camcorder: Model Pro846



Remote Control
Stock No. 221363

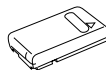

Rechargeable 6-Volt Battery
Stock No. BV060

**WARNING: NICKEL
CADMIUM BATTERY
MUST BE DISPOSED
OF PROPERLY.**



DC Cable
Stock No. 221364

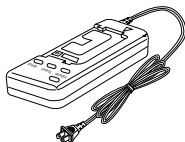

AC Adapter/Charger
Stock No. 221361

Caution:
Do not use this adapter/charger for any other purpose other than charging the BV060, BB150, or BB060 battery pack or supplying power to the camcorder.



Lens Cap Cord
Stock No. 221393



Shoulder Strap
Stock No. 215770

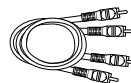

Audio/Video Output Cable
Stock No. 221357



Clock and Remote Cells
3-Volt Micro Lithium Cells – such as CR2025 are available from most local drug stores and camera shops. Use of other cells present a risk of fire or explosion.

Cautions: Lithium cell batteries. Must be disposed of properly. Never handle punctured or leaking cells. May cause burns or personal injury.

Keep out of the hands of children. Can cause death or injury if swallowed. If swallowed, consult a physician immediately for emergency treatment.

The lithium cells used in these devices may explode resulting in a fire or chemical burn if mistreated. Do not recharge, disassemble, heat above 212°F (100°C), or incinerate.

Never use metallic tweezers to hold the cells, and never short circuit the + and – sides of the cells.

First-Time Operation

2. Attach the adapter/charger.

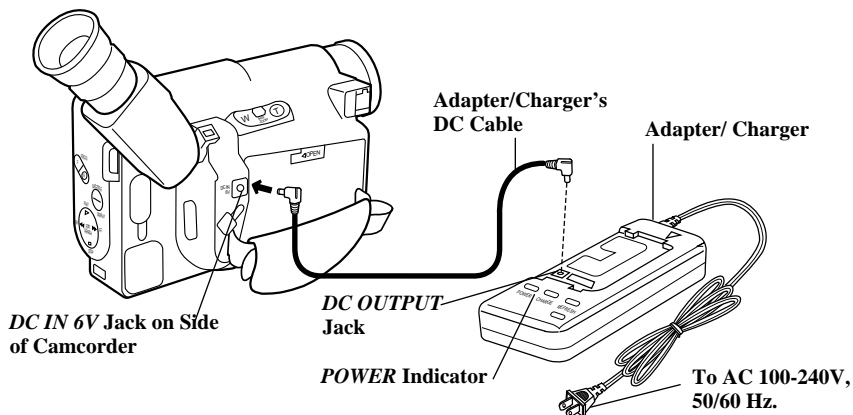

Since the battery must be charged before it can be used the first time, attach the adapter/charger.

- Attach one end of the adapter/charger's DC cable to the DC OUTPUT jack on the adapter/charger.
- Attach the other end of the cable to the DC IN 6V jack on the camcorder.

- Plug the adapter/charger's plug into an operating outlet.
- *Details are on page 12.*

Notes: *Details on using the rechargeable battery are on page 14.*

You can also use six alkaline "AA" batteries to power the camcorder. *Details are on page 16.*

3. Insert a cassette.

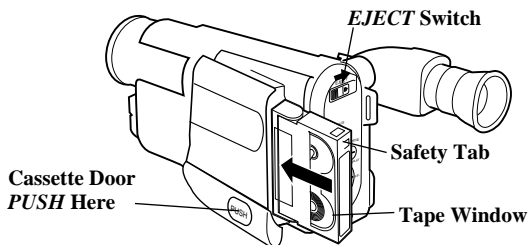

- A. Slide *EJECT* to open the cassette compartment.
- B. Fully insert cassette with tape window and safety tab facing out.

- C. Gently close compartment door by pressing on the area labeled *PUSH* until the door clicks into place.
Details are on page 21.

First-Time Operation

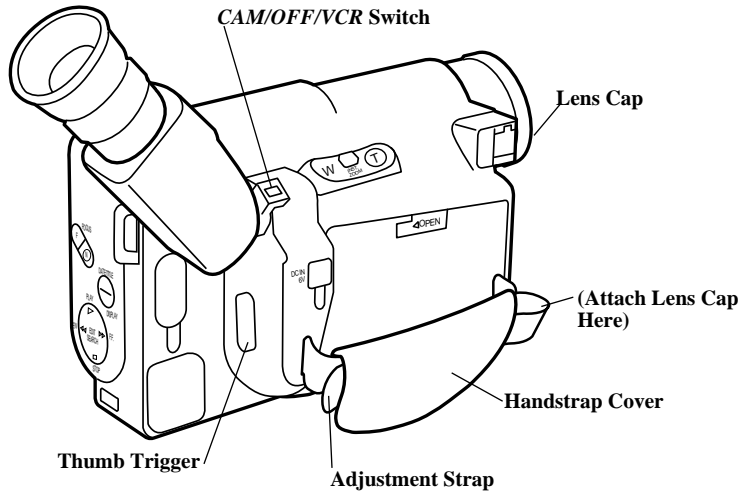

4. Attach the lens cap cord and adjust the handstrap.

- A. Remove the lens cap from the camcorder.
- B. Attach the lens cap cord to the lens cap.

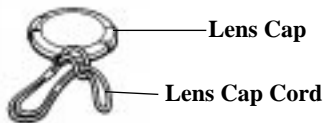

- C. Unsnap the handstrap cover and open the adjustment strap.

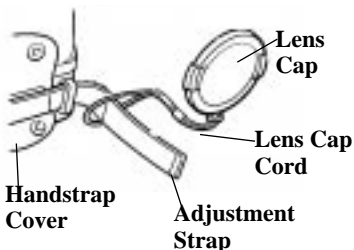

- D. Put the lens cap cord over the adjustment strap.

E. Put your hand in the handstrap.

F. Pull the adjustment strap to tighten and close the strap.

G. Snap the cover shut.

H. Attach the lens cap to the handstrap.

5. Turn on the camcorder.

The *CAM/OFF/VCR* switch tells the camcorder whether you want to record (*CAM*), play back tapes (*VCR*), or turn off the camcorder's power (*OFF*).

Some of the controls operate differently depending on the position of the *CAM/OFF/VCR* switch.

- Press and hold the small button on *CAM/OFF/VCR* while sliding it to *CAM* or *VCR*.

Important Note: The *TAPE* indicator will flash in the viewfinder when there is moisture in the camcorder. Remove the tape and wait an hour before inserting the tape in the camcorder again.

(continued on next page)

First-Time Operation

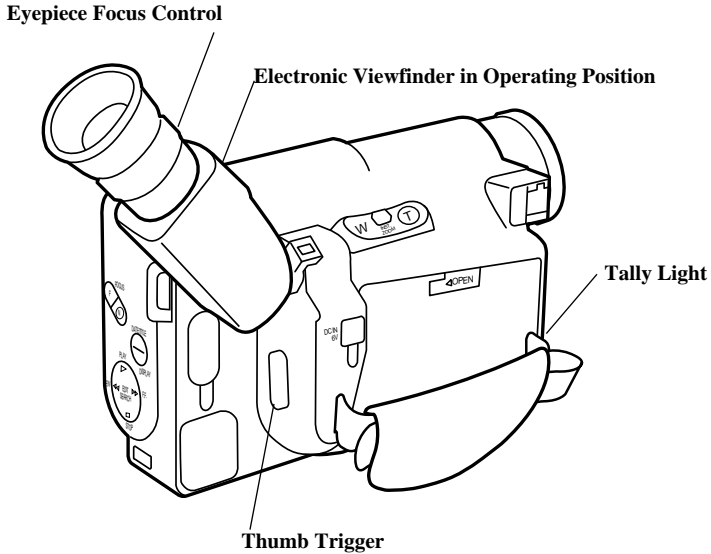

6. Adjust eyepiece focus control for your vision.

- A. Rotate viewfinder into a comfortable viewing position.
- B. If the image in the viewfinder is blurry, adjust the eyepiece focus control for your vision.

Details are on page 29.

7. Start and stop recording.

Start and stop recording by pressing and releasing the thumb trigger. You do not have to hold the thumb trigger to record. The tally light will light and *REC* will appear in the viewfinder when the camcorder is recording.

Notes: If you do not record within five minutes, the camcorder will automatically shut off to prevent excessive tape wear. If this happens, press the thumb trigger.

Any material recorded on the tape will automatically be erased if you record over it.

First-Time Operation

8. Play back what you have recorded.

- A. Press thumb trigger to stop recording.
- B. Place *CAM/OFF/VCR* in *VCR*.
- C. Press *REW* to rewind the tape.
- D. Press *PLAY* to play back the tape in the viewfinder.
- E. Press *STOP* when you are finished.
- F. *Details on viewfinder playback are on page 48.*

9. Review camcorder's operating controls.

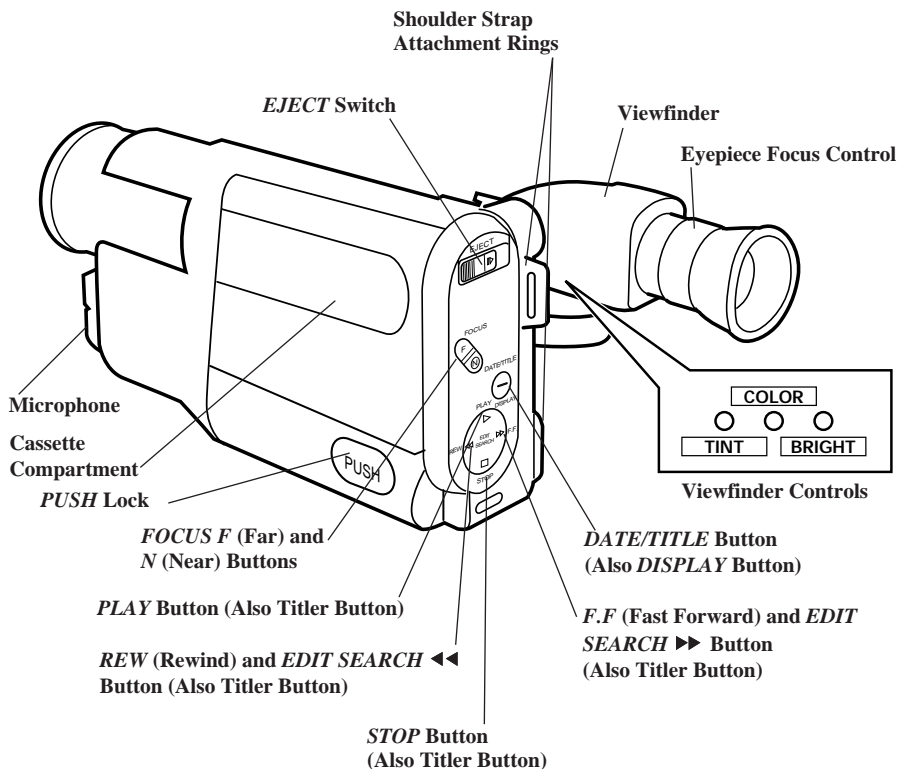

(continued on next page)

First-Time Operation

9. Review camcorder's operating controls. (continued)

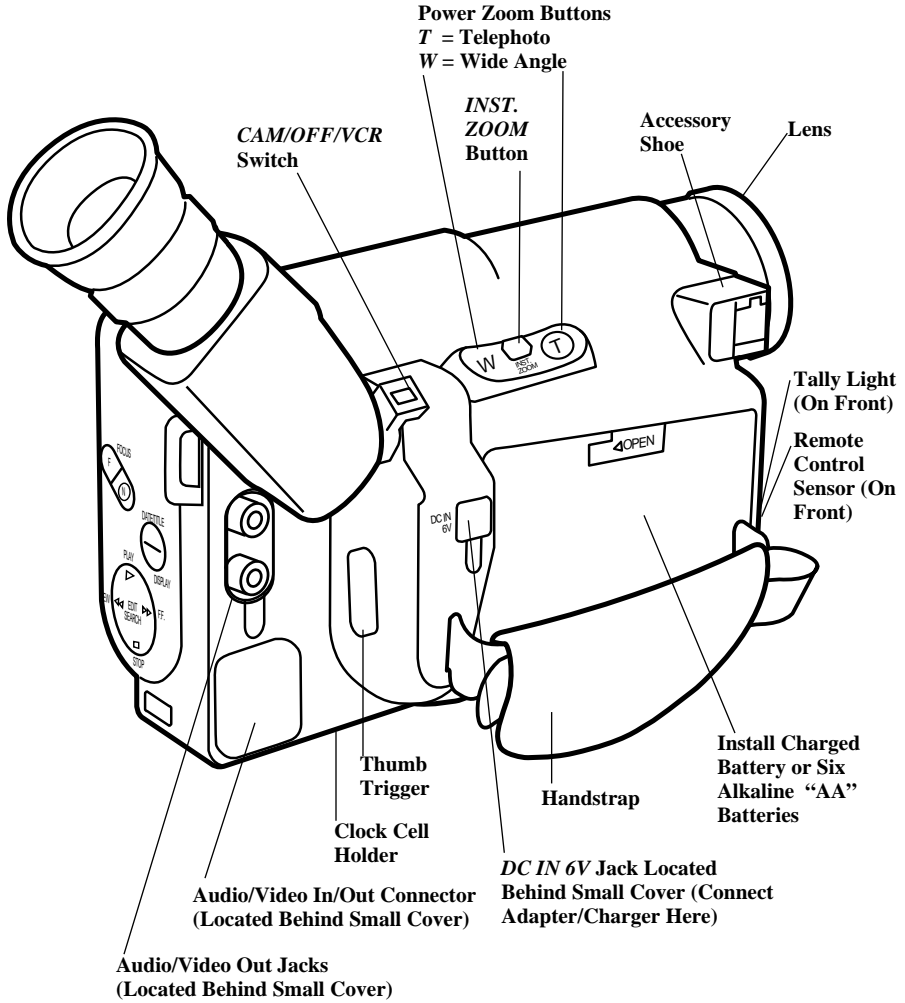

Remote Control

Install Remote Battery



1. Turn remote over, insert a pin or straightened paper clip in the pin hole, and remove the battery holder.
2. Insert battery so positive (+) terminal faces up.
3. Replace battery holder.

Notes: Never place anything heavy on top of the remote control or lay it upside-down.

Replace battery when camcorder fails to respond to remote.

Remove the battery from the remote if it will not be used for a month or more. This will prevent possible damage from battery leakage. If leakage occurs, wipe up the liquid inside the compartment and replace the battery.

Cautions: Lithium cell battery. Must be disposed of properly. Never handle a punctured or leaking cell. May cause burns or personal injury.

Keep out of the hands of children. Can cause death or injury if swallowed. If swallowed, consult a physician immediately for emergency treatment.

The lithium cell used in this device may explode resulting in a fire or chemical burn if mistreated. Do not recharge, disassemble, heat above 212°F (100°C), or incinerate.

Never use metallic tweezers to hold the cell, and never short circuit the + and – sides of the cell.

Remote Sensor

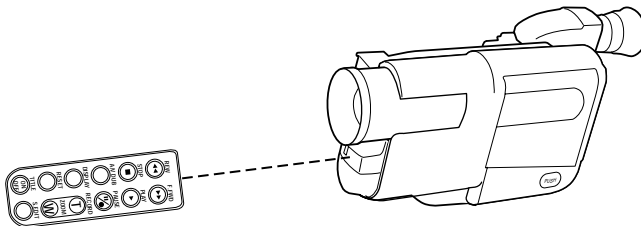

The remote operates the camcorder by infrared light, so it is protected from electrical and sound interference.

However, the remote must be aimed directly at the camcorder's remote sensor. There cannot be any obstructions between them.

Note: The camcorder may not respond to the remote control if the camcorder's remote sensor is exposed to direct sunlight or strong artificial light.

Remote Control

Location and Function of Remote Buttons

A brief description of the functions of the remote buttons is given here. Some buttons perform the same function as the corresponding controls on your camcorder. You can use whichever is more convenient at the time.

Note: An RCA VCR that is set to respond to *VCR 2* on the VCR's remote may respond to this remote when it is used to operate the camcorder.

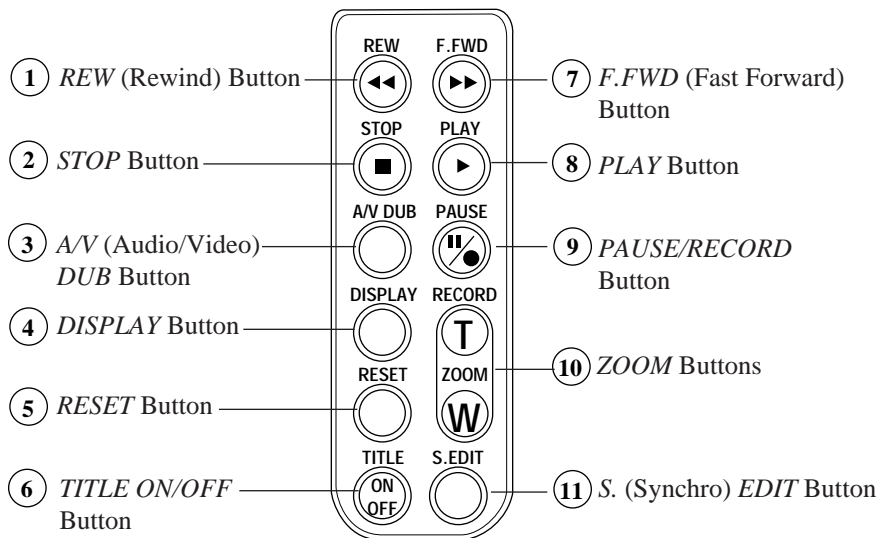

1 *REW* (Rewind) Button

- Press *REW* when the camcorder's *CAM/OFF/VCR* switch is in *VCR* to rewind the tape.
- Press and hold *REW* during playback (camcorder's *CAM/OFF/VCR* switch in *VCR*) to visually search the tape in reverse at a higher speed. Release *REW* to return to normal playback.
- Press and hold *REW* when the camcorder's *CAM/OFF/VCR* switch is in *CAM* to visually search the recorded material in reverse. When you release *REW*, the camcorder will stop searching and prepare to record at that point on the tape.

Remote Control

② **STOP Button**

- Press *STOP* when the camcorder's *CAM/OFF/VCR* switch is in *VCR* to stop playback, rewinding, or fast forwarding.
- *STOP* has no effect when the camcorder's *CAM/OFF/VCR* switch is in *CAM*. To stop recording, press *PAUSE/RECORD*.

③ **A/V (Audio/Video) DUB Button**

- Use this button to record new audio and video in place of existing audio and video on a recorded tape.
- *Details are on pages 38-39.*

④ **DISPLAY Button**

- Press *DISPLAY* to turn the time counter's memory-stop feature on and off.

⑤ **RESET Button**

- Press *RESET* to set the time counter back to "0:00:00".

⑥ **TITLE ON/OFF Button**

- Press *TITLE ON/OFF* to display and remove the titler graphics from the viewfinder.
- *Details are on pages 36-37.*

⑦ **F.FWD (Fast Forward) Button**

- Press *F.FWD* when the camcorder's *CAM/OFF/VCR* switch is in *VCR* to fast forward the tape.
- Press and hold *F.FWD* during playback (camcorder's *CAM/OFF/VCR* switch in *VCR*) to visually search the tape forward at a high speed. Release *F.FWD* to return to normal playback.
- Press and hold *F.FWD* when the camcorder's *CAM/OFF/VCR* switch

is in *CAM* to visually search the recorded material forward. When you release the *F.FWD* button, the camcorder will stop searching, and prepare to record at that point on the tape.

⑧ **PLAY Button**

- Press *PLAY* when the camcorder's *CAM/OFF/VCR* switch is in *VCR* to begin playback.
- Press and hold *PLAY* when the camcorder's *CAM/OFF/VCR* switch is in *CAM* to view the recorded material at normal speed. When you release *PLAY*, the camcorder will stop playing and prepare to record at that point on the tape.

⑨ **PAUSE/RECORD Button (Same as Thumb Trigger on Camcorder)**

- Press and release *PAUSE/RECORD* when the *CAM/OFF/VCR* switch is in *CAM* to start and stop recording.
- Press *PAUSE/RECORD* during playback (camcorder's *CAM/OFF/VCR* switch in *VCR*) to produce a stop-action picture. Press *PAUSE/RECORD* again to return to normal playback.

⑩ **ZOOM (W and T) Buttons**

- Press and hold *W ZOOM* to move the lens in the wide-angle direction.
- Press and hold *T ZOOM* to move the lens in the telephoto direction.

⑪ **S. (Synchro) EDIT Button**

- Use this button to synchro edit.
- *Details on pages 40-41.*

Powering Your Camcorder

Using the Adapter/Charger to Power Your Camcorder

The adapter/charger attaches to the camcorder and lets you power your camcorder directly from standard household power. The adapter/charger operates on 100-240 volts, 50/60 Hz.

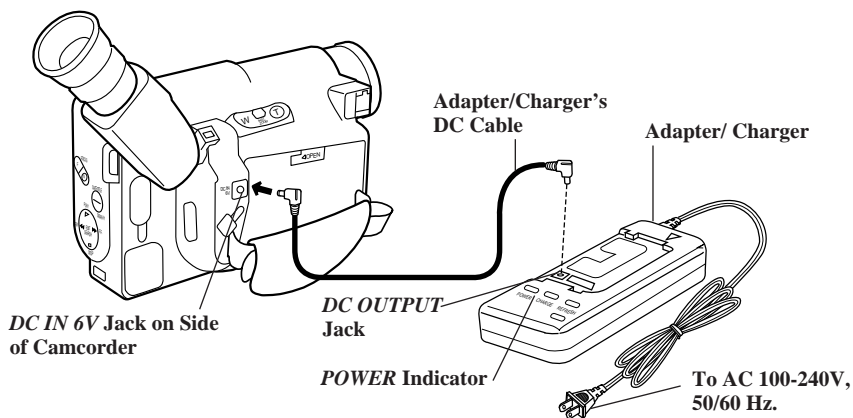

To Attach the Adapter/Charger

1. Make sure the *CAM/OFF/VCR* switch is in *OFF*.
2. Connect the DC cable's small plug into the *DC OUTPUT* jack on the adapter/charger.
3. Attach the other end of the cable to the *DC IN 6V* jack on the camcorder.
4. Plug the adapter/charger's plug into the nearest AC outlet (100-240V, 50/60Hz).
5. If the adapter/charger is properly connected, its *POWER* indicator will light.

Note: The battery level indicator has no meaning when using the adapter/charger to power the camcorder.

To Remove the Adapter/Charger

1. Unplug the adapter/charger from the wall outlet.
2. Remove the DC cable from the *DC IN 6V* jack on the camcorder.

Using an Optional Plug Adapter

An optional plug adapter may be required in some countries.

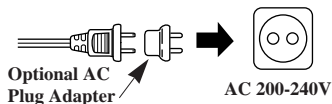

1. Plug the adapter/charger's plug into the AC plug adapter.
2. Plug the AC plug adapter into an AC outlet.

Powering Your Camcorder

Using the Rechargeable Battery to Power Your Camcorder

The battery must be charged before it can be used the first time. Initial charging will take approximately one hour. When fully charged, the battery should supply about 45-55 minutes of operating time (depending on how much you use zoom and pause).

Note: Use the small marker switch on the top of the battery as a reminder to help you remember to recharge the battery. It has no other function.

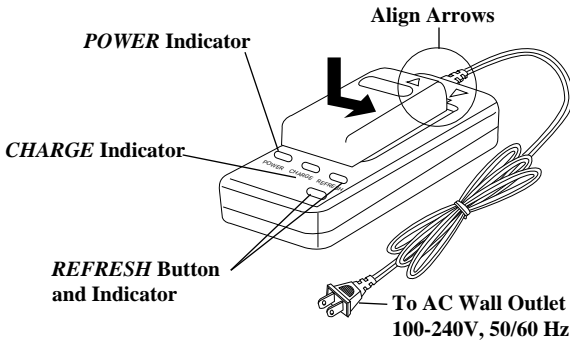

Caution:
When a battery is attached to the adapter/charger, do not turn them upside down. The battery may fall off and be damaged or cause injury.

Charging and Refreshing the Battery

If the DC cable is attached to the adapter/charger, remove its plug.

1. Align the reference arrow on the battery with the arrow on the adapter/charger.
2. Hold the battery flush against the adapter/charger, and slide it in the direction of the arrow.
3. Plug the adapter/charger into the nearest AC outlet (100-240V, 50/60Hz).
4. The adapter/charger's *CHARGE* indicator will light. After the battery has been used, press *REFRESH* to refresh the battery before recharging it. The *REFRESH* indicator will light. After refreshing is completed, the *CHARGE* indicator will light and the battery will charge. When the *CHARGE* indicator turns off, the battery is fully charged.

Notes: The battery will provide longer performance if you refresh it before each charging. Refreshing and charging will take approximately 4-1/2 hours.

If *POWER* on the adapter/charger starts flashing, remove the plug from the outlet for about 30 seconds. Then reattach it. If after several attempts, *POWER* continues to flash, your battery cannot take a charge and must be replaced.

POWER will also flash if a hot battery is attached to the adapter/charger. Attaching an extremely hot battery is not recommended. Allow it to cool down before attaching it.

5. Slide the charged battery off the adapter/charger and insert it in the camcorder *as shown on the next page*.

(continued on next page)

Powering Your Camcorder

Using the Rechargeable Battery to Power Your Camcorder

Insert the Battery

1. Make sure the *CAM/OFF/VCR* switch is in *OFF*.
2. Lift the *OPEN* lever and pull up the battery compartment cover.
5. Close the battery compartment cover. Hold the *OPEN* lever and align the tabs on the cover with the tabs on the compartment.

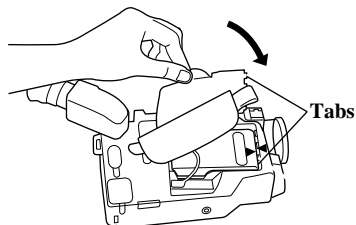
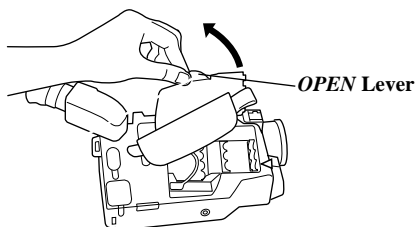

3. Insert the battery into the battery compartment aligning the reference marks.

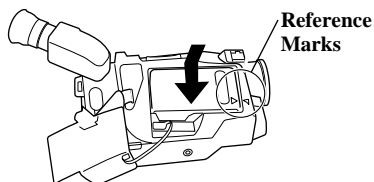

4. Press and hold the battery while sliding it in the direction of the arrow.

Notes: The *OPEN* lever must be open for the cover to close.
Remove the battery from the camcorder when not in use.

Remove the Battery

1. Make sure the *CAM/OFF/VCR* switch is in *OFF*.
2. Lift the *OPEN* lever and pull up the battery compartment cover.
3. Slide the battery in the direction of the arrow until you hear a click.
4. Remove the battery from the compartment
5. Close the battery compartment cover. Hold the *OPEN* lever and align the tabs on the cover with the tabs on the compartment.

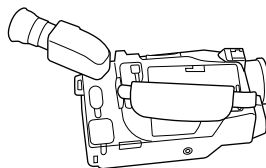
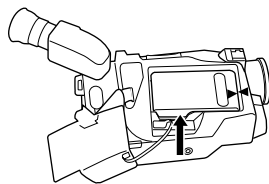

Powering Your Camcorder

Proper Care and Storage of Your Battery

The battery will provide better service and longer performance if you refresh it before charging and store it at normal room temperature.

Do not operate the battery at temperatures below 14°F (-10°C) or above 95°F (35°C). The battery may be damaged if operated at temperatures above 122°F (50°C). Operation time will decrease at extremely low temperatures.

After repeated chargings and use, the operation time will gradually decrease. When operation time becomes too short to be useful, it is time to replace the battery.

Charge the battery at a temperature of 32°F-95°F (0°C-35°C) to prevent damage.

Battery Safety Precautions

Do not short the battery's terminals.

Do not attempt to disassemble or modify the battery. There are no user-serviceable parts inside.

Use the battery only with specified adapter/chargers and camcorders.

ATTENTION: NICKEL CADMIUM BATTERY MUST BE DISPOSED OF PROPERLY. THE PRODUCT THAT YOU HAVE PURCHASED CONTAINS A RECHARGEABLE BATTERY. AT THE END OF ITS USEFUL LIFE, UNDER VARIOUS STATE AND LOCAL LAWS, IT MAY BE ILLEGAL TO DISPOSE OF THIS BATTERY INTO THE MUNICIPAL WASTE STREAM. CHECK WITH YOUR LOCAL SOLID WASTE OFFICIALS FOR DETAILS IN YOUR AREA FOR RECYCLING OPTIONS OR PROPER DISPOSAL.

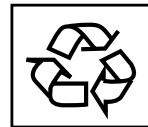

Ni - Cd

Powering Your Camcorder

Using Alkaline “AA” Batteries to Power Your Camcorder

The camcorder can be powered by six alkaline dry-cell “AA” batteries. The operation time of the camcorder depends on the type of alkaline batteries used.

Insert the Batteries

1. Make sure the *CAM/OFF/VCR* switch is in *OFF*.
2. Lift the *OPEN* lever and pull up the battery compartment cover.
5. Close the battery compartment cover. Hold the *OPEN* lever and align the tabs on the cover with the tabs on the compartment.

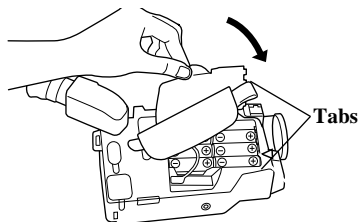
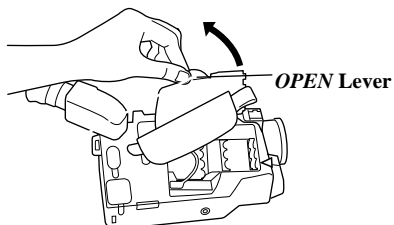

3. Lift the two partitions in the battery compartment.

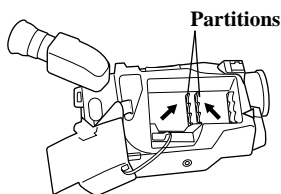

4. Insert six alkaline batteries into the compartment matching the polarities (+ and -) on the batteries to the battery compartment *as shown below*.

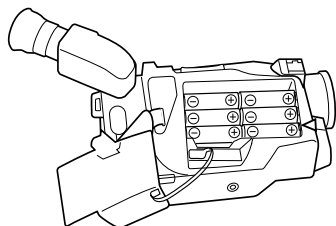

Notes: The *OPEN* lever must be open for the cover to close.

The camcorder may not operate properly in cold temperatures.

The camcorder and battery level indicator may not operate properly when the batteries need to be replaced.

Noise may occur at the beginning and end of recordings.

Using a light will shorten the operation time of the batteries.

Remove at least one battery if you will not be using the camcorder for a long period of time to extend the batteries useful life.

(continued on next page)

Powering Your Camcorder

Safety Precautions When Using Alkaline Batteries

Do not short, disassemble, heat, or throw the batteries into the fire.

Batteries become warm during and after use. Use caution when removing them.

Use “AA” alkaline batteries only during their recommended lifetime.

Remove at least one battery if you will not be using the camcorder for a long period of time to extend the batteries useful life.

Do not use manganese batteries to power the camcorder.

To reduce the risk of battery leakage or an explosion:



- Make sure battery is inserted with correct polarity.
- Remove the batteries from the camcorder before storing it.
- Do not use old and new batteries at the same time or mix brands of batteries.
- If the batteries leak, remove the batteries and carefully wipe up the fluid.
- Keep the terminals clean. Use a dry cloth to wipe any dirt off the terminals.

Checking Battery Power (Battery Level Indicator)

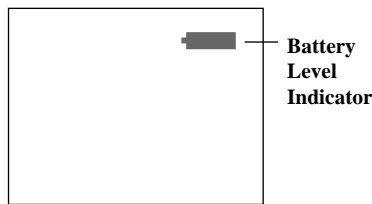
The battery level indicator shows how much recording time is left on the rechargeable or alkaline batteries. This indicator will not be recorded on the tape.



Display in Viewfinder

- When the battery is fully charged, the display shows  in the viewfinder.
- After several minutes, the display shows .
- When the battery level display  starts flashing, it is time to recharge (or replace) the batteries.

Note: The battery level indicator may not operate properly when using “AA” batteries that need to be replaced.

Caution: The camcorder will shut off when the battery reaches empty. The battery or “AA” batteries should still eject the cassette when you slide *EJECT*. If it does not, do not attempt to force the cassette compartment open. This will damage the camcorder.

Powering Your Camcorder

Using the Optional Thomson Car Cord Adapters

The optional DCC06 car cord adapter and DCC80 car cord adapter/charger allow you to power your camcorder from the cigarette lighter socket of a car, truck, or RV. They convert 24- and 12-volts to a 6-volt output. The DCC80 can also charge the battery that came with your camcorder and the BB150 battery.

Notes: Consult instructions enclosed with the DCC06 or DCC80 for details.

The vehicle's engine does not have to be turned on when using the car cords.

When using the car cords, the battery level indicator has no meaning.

Optional accessories are shown on pages 55-61.

Cautions: The DCC06 and DCC80 are designed to be used only with vehicles having negative ground electrical systems.

Do not use any other car cords. They will damage your camcorder.

Using the DCC06 Car Cord Adapter to Power the Camcorder

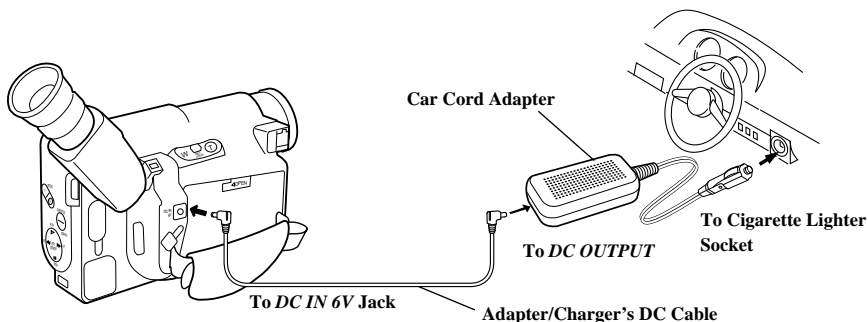

1. Make sure the camcorder's **CAM/OFF/VCR** switch is in **OFF**.
2. Connect the DC cable's small plug into the **DC OUTPUT** jack on the car cord adapter.
3. Attach the other end of the cable to the **DC IN 6V** jack on the camcorder.
4. Insert plug of car cord adapter into vehicle cigarette lighter's socket.
5. Press and hold the small button on the **CAM/OFF/VCR** switch while sliding it in **CAM**.

Powering Your Camcorder

Use DCC80 Car Cord Adapter/Charger to Power Camcorder

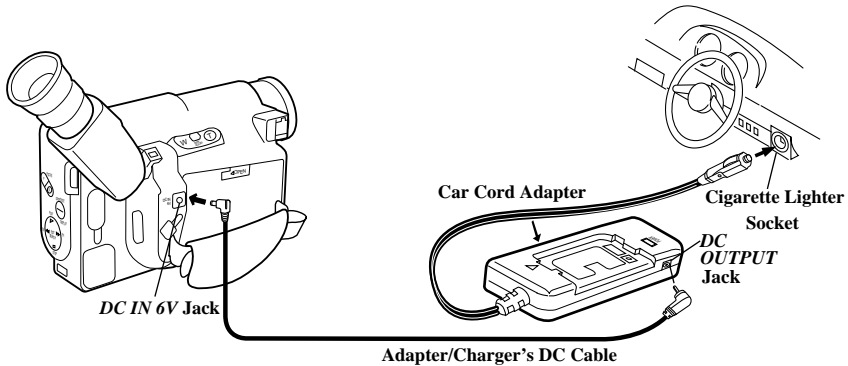

1. Make sure the camcorder's **CAM/OFF/VCR** switch is in **OFF**.
2. Connect the DC cable's small plug into the **DC OUTPUT** jack on the car cord adapter/charger.
3. Attach the other end of the cable to the **DC IN 6V** jack on the camcorder.
4. Insert plug of car cord adapter/charger into vehicle cigarette lighter's socket.
5. Press and hold the small button on the **CAM/OFF/VCR** switch while sliding it in **CAM**.

Using DCC80 Car Cord Adapter/Charger to Charge a Battery

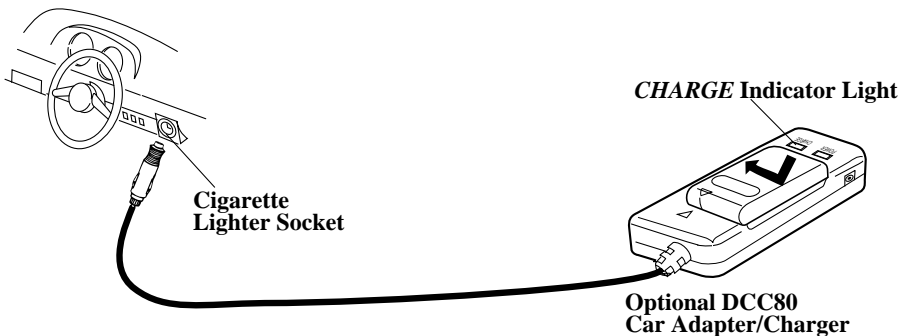

1. If the DC cable's plug is attached to the adapter/charger, remove it.
2. Attach the battery *as shown*.
3. The **CHARGE** indicator will light while the battery is being charged. When the **CHARGE** indicator turns off, the battery is charged.

Video Cassettes

We recommend RCA cassettes be used with your camcorder. Use of poor quality or damaged tapes can contaminate the video heads, resulting in snow or no picture during playback. Head cleaning is not covered under warranty. It is considered normal maintenance. Playing a new RCA tape for approximately 30 minutes will often satisfactorily clean the heads and improve your picture.

Erase Protection – Safety Tab

You can use your video cassettes over and over again. To erase a previous recording, just record over it.

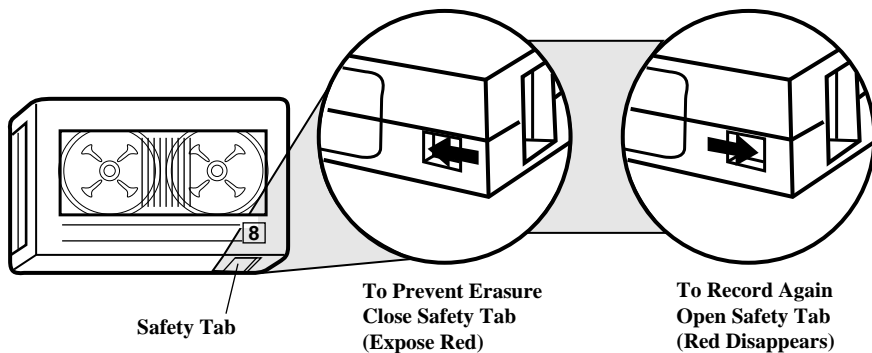

Recording and Playback Speed and Times

The camcorder records and plays back in standard speed (SP). Listed below are the maximum SP recording times for some popular 8mm cassettes.

Cassette	Recording Time
P6-15	15 Minutes
P6-20	20 Minutes
P6-45	45 Minutes
P6-60	60 Minutes
P6-90	90 Minutes
P6-120	2 Hours
P6-150	2 1/2 Hours

Video Cassettes

Inserting and Removing Cassettes

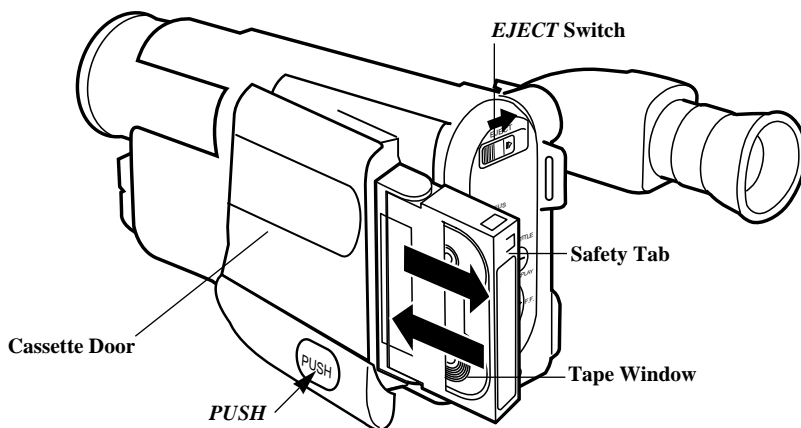

Caution: Insert the cassette with the safety tab and tape window facing out. The cassette should slide easily in the compartment. Do not force it.

1. Slide *EJECT* to open the cassette compartment.
2. Fully insert cassette with tape window and safety tab facing out.
3. Gently close compartment door by pressing on the area labeled *PUSH* until the door clicks into place.
4. When you are finished with a cassette, rewind it, remove it from the camcorder, and label it.

Cassette Care and Storage

- Close the safety tab to prevent accidental erasure.
- Do not use a cassette if it has been damaged or exposed to moisture.
- Do not touch or cover the small holes in the cassette or use cassettes with damaged or spliced tape.
- Store cassettes vertically in their protective cases at normal room temperatures. Excessive heat or cold may damage your cassettes.
- Keep the cassette away from strong magnetic fields such as electric motors and other devices.

Recording Features

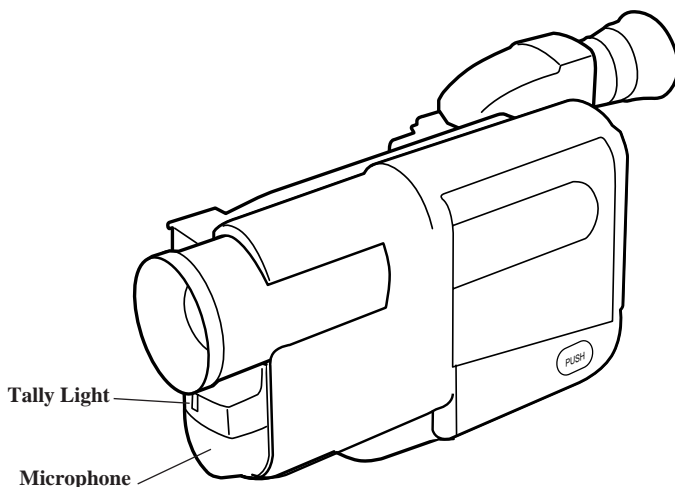

Microphone

The microphone picks up the sound during a recording. It is more sensitive to sounds coming from the direction the lens is pointed.

Flying Erase Head

A separate erase head is mounted on the spinning headwheel (hence the term “flying”).

This allows you to make clean edits without the “glitches” or “rainbow noise” that may occur.

Tally Light

The tally light on the front of the camcorder lights when the camcorder is recording.

Quick Review

Press and release *EDIT SEARCH* ◀◀ (*REW* on remote) when the camcorder is in record pause to review the last few seconds of a recording.

The camcorder will play back the last few seconds of the recording, return the tape to its previous position, and return to record pause.

Note: Do not press and hold *EDIT SEARCH* ◀◀ or the camcorder will go into edit search.

Recording Features

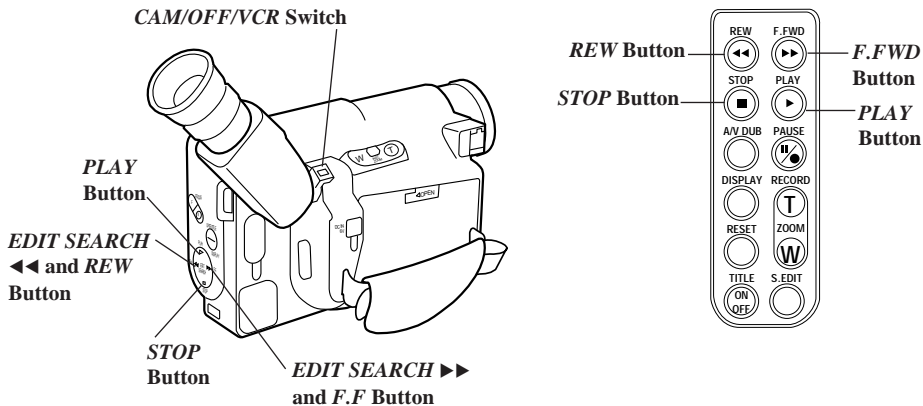

Edit Search

Edit search uses *EDIT SEARCH* ◀◀, *EDIT SEARCH* ▶▶ (*REW* and *F.FWD* on remote), and *PLAY* to precisely position the tape while the camcorder is in record pause.

- Press and hold *EDIT SEARCH* ◀◀ to visually search the recorded tape in reverse.
- Press and hold *EDIT SEARCH* ▶▶ to visually search forward on the recorded tape.
- Press and hold *PLAY* to view the recorded tape at normal speed.

Release the button for the camcorder to return to record pause at that point on the tape.

Tape Positioning

When the *CAM/OFF/VCR* switch is in *VCR* and the camcorder is stopped, you can quickly fast-forward or rewind the tape.

- Press *F.F* (*F.FWD* on remote) to fast-forward the tape. Press *STOP* to stop fast-forwarding.
- Press *REW* to rewind the tape to the beginning. Press *STOP* to stop rewinding.

Recording Features

Time-Remaining Display



The time-remaining display shows the amount of recording or playback time left on the tape in the camcorder.

The display will display “-----” for approximately ten seconds when you first start playing or recording a tape while the camcorder calculates the time remaining. After the time is calculated, the time-remaining indicator appears in the viewfinder.

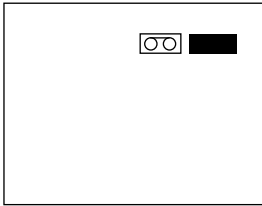
- *TAPE END* flashes when there is approximately three minutes of recording time left on the cassette.
- *TAPE END* appears briefly during recording when the end of the cassette is reached.



Note: Once time remaining has been calculated, it will automatically be updated and readily available as long as the same tape remains in the camcorder.

When the cassette is full,   appears.

The  changes in size to indicate how much recording or playback time is left on the cassette.

Program AE (Auto Exposure)

Program auto exposure automatically selects the shutter speed and adjusts the iris according to the shutter speed.

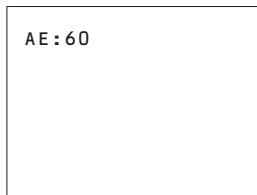

**Auto Exposure Display
in Viewfinder**

The *AE* indicator for the shutter speed selected (*1/60, 1/100, 1/120, 1/180, 1/250, 1/350, 1/500, 1/750, 1/1000,*

1/1500, 1/2000, or 1/4000 second) appears in the viewfinder.

Recording Features

Date Search

You can search for the beginning and end of recordings you make on a certain day.

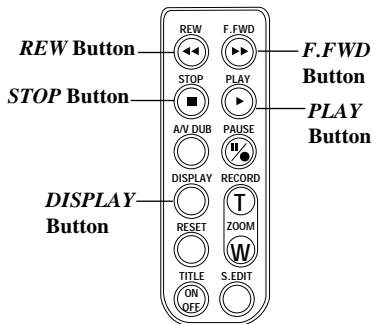
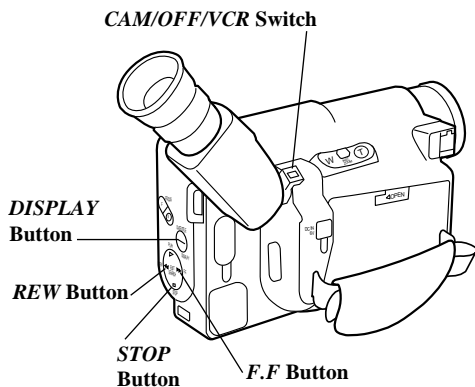

To Date Search

The clock cell battery must be installed and the date and time set. The cassette must remain in the camcorder for this feature to operate.

1. Attach a power supply and place the CAM/OFF/VCR switch in VCR.
2. Repeatedly press DISPLAY to display SEARCH in the viewfinder.



3. If you are in the middle of your recording for that day, press REW to search for the place you started recording that day or F.F (F.FWD on

remote) to search for the place you stopped recording.

When the camcorder locates the beginning or end of the recording, it will enter the stop mode. SEARCH disappears from the viewfinder.

Notes: The cassette must remain in the camcorder for this feature to function. If you insert a cassette and start recording, this location will be the starting position for that day.

This feature will only operate on cassettes recorded on this camcorder.

To Stop Date Search

Press STOP to stop a search in progress.

Date and Time Display

Set the Date and Time

The clock cell must be installed *as shown on page 28* before you set the clock.

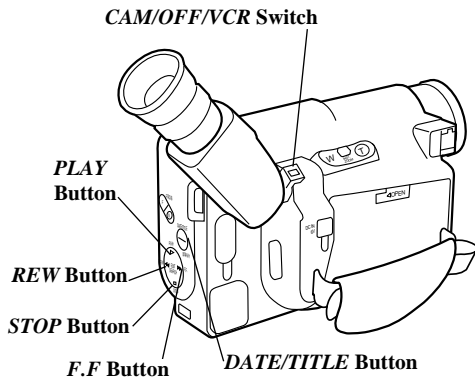

1. Attach a power supply to the camcorder. Press and hold the small button on the *CAM/OFF/VCR* switch while you slide it in *CAM*.
2. If the date and time display does not appear in the viewfinder, press *DATE/TITLE*.
3. A flashing cursor lets you know which part of the display you are setting. Press the *F.F* or *REW* button repeatedly until the correct month appears.
4. Then press *STOP*. The flashing cursor will move to the next part of the display.
5. Repeat steps 3 and 4 until you have entered the correct month, day, year, hour, minute, and *AM* or *PM*.
6. After you select *AM* or *PM*, press *DATE/TITLE* to remove the flashing cursor from the viewfinder and start the camcorder's internal clock.

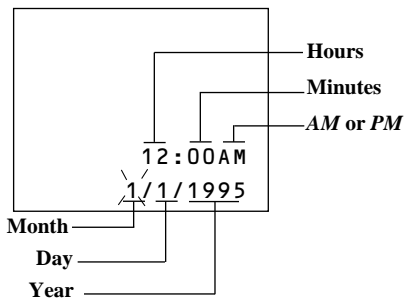

Correct the Date or Time

To correct the date or time after the clock has been started, simultaneously press *DATE/TITLE* and *STOP*. Then correct the date or time using *REW*, *F.F*, and *STOP*.

Date and Time Display

Recording Date and Time, Date, or Date and Title on Your Tape

The time and date, date only, or date and title can be recorded on your tape. Whenever one of the displays appears in the viewfinder, it will be recorded. The camcorder also has auto date and auto title features.

The clock cell must be installed and the clock set.

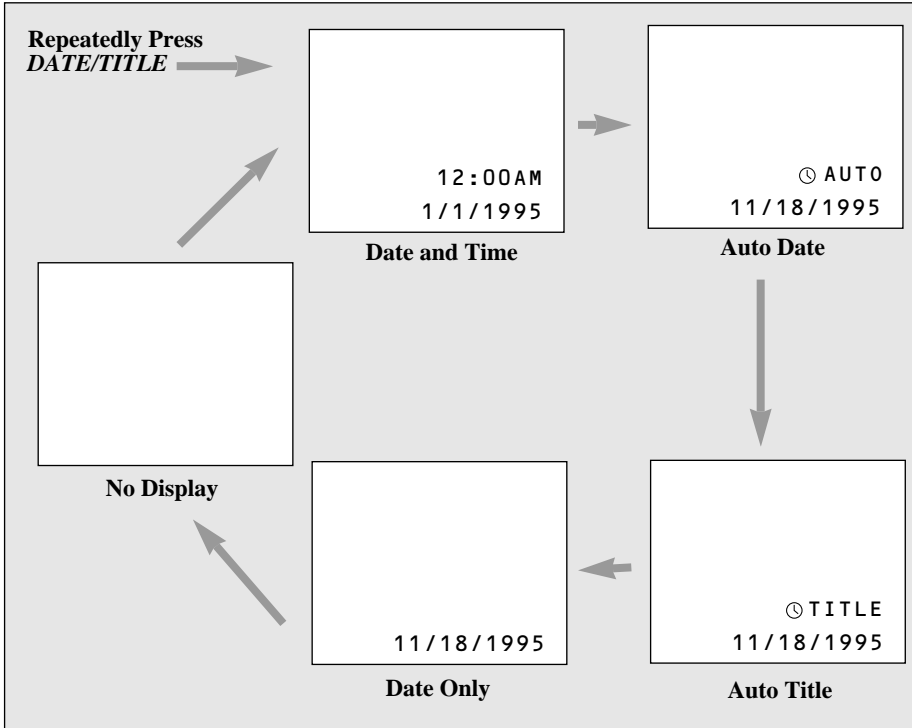

To Select Display to Record

1. Repeatedly press *DATE/TITLE* to select the display you want to record.
 - Select date and time to continuously record the date and time.
 - Select Ⓞ *AUTO* to automatically record the date for ten seconds at the beginning of the recording.
 - Select Ⓞ *TITLE* to automatically record the title and date for ten seconds at the beginning of the recording.
 - Select date only to continuously record the date.
 - Select no display if you do not want any of the displays recorded.

Date and Time Display

Install the Clock Lithium Cell

1. Make sure camcorder is turned off, and remove any power supply attached to the camcorder.
2. Pull out the cell holder.
3. Insert the clock cell into the cell holder with the “+” terminal facing out.
4. Place the cell holder into the camcorder.

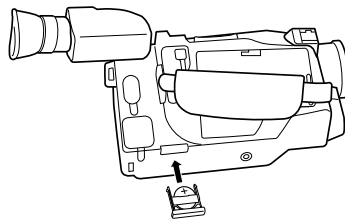
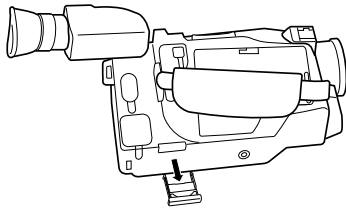

3. Insert the clock cell into the cell holder with the “+” terminal facing out.

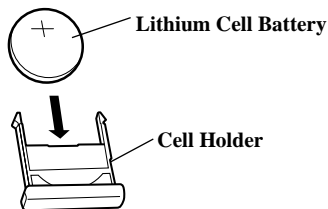

Note: Remove the battery from the camcorder if it will not be used for a month or more. This will prevent possible damage from battery leakage. If leakage occurs, wipe up the liquid inside the compartment and replace the battery.

Cautions: Lithium cell battery. Must be disposed of properly. Never handle a punctured or leaking cell. May cause burns or personal injury. Keep out of the hands of children. Can cause death or injury if swallowed. If swallowed, consult a physician immediately for emergency treatment. The lithium cell used in this device may explode resulting in a fire or chemical burn if mistreated. Do not recharge, disassemble, heat above 212°F (100°C), or incinerate. Never use metallic tweezers to hold the cell, and never short circuit the + and – sides of the cell.

Viewfinder

The camcorder's viewfinder is a miniature monitor that displays the picture seen by the lens.

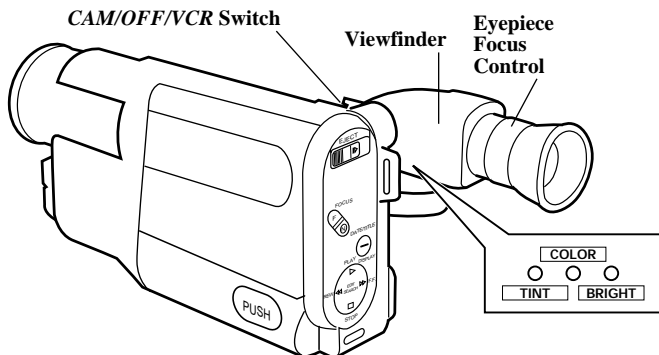

Eyepiece Focus Control

The eyepiece focus control lets you set the focus of the viewfinder for your personal vision. If you wear eyeglasses, you can probably operate the camcorder without them.

1. Attach a power supply to the camcorder. Press and hold the small button on the *CAM/OFF/VCR* switch while you slide it to *CAM*.
2. Adjust the eyepiece focus control for your vision. Focus on one of the on-

screen displays (such as the time counter).

The eyepiece focus control does not affect the focus of the picture actually recorded by the camcorder.

COLOR, TINT, and BRIGHT Controls

These small controls are set at the factory and should require no adjustment. If adjustment is needed, use a small plastic screw driver to prevent damaging the miniature controls.

Tilt Adjustment

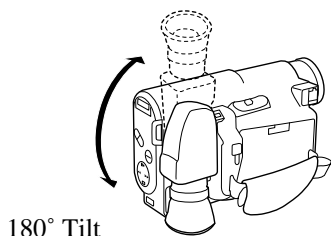

Caution: Do not force the viewfinder to rotate completely around. This will damage the viewfinder and/or the camcorder.

Caution: When carrying the camcorder with the shoulder strap, rotate the viewfinder down to prevent possible damage to the viewfinder from bumping against your body as you move.

Displays in Viewfinder

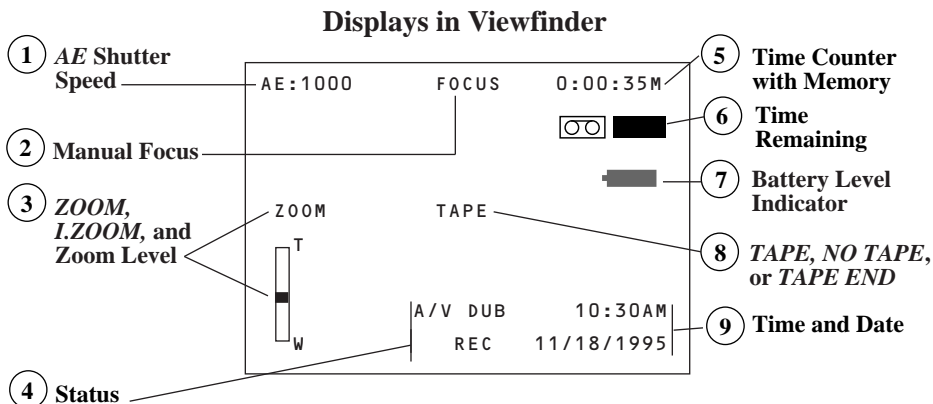

Several displays that aid in the operation of the camcorder appear in the viewfinder. The only display that is recorded on the tape when it appears is the date display.

① AE (Auto Exposure) Shutter Speed Displays

The shutter speed selected by the camcorder appears here.

② Manual Focus

- *FOCUS* appears when manual focus is turned on.
- No indicator appears when auto focus is turned on.
- Press both *FOCUS* buttons together to turn auto focus on and off.

③ ZOOM, I.ZOOM, and Zoom Level Indicator

- The zoom level indicator appears during zooming.
- *ZOOM* appears when you press *T* and zoom in the telephoto direction more than twelve times.
- *I.ZOOM* appears when you press *INST. ZOOM* to enlarge the picture 1.5 times.

④ Status

The following status displays appear.

- *REC* appears during recording.
- **▶▶** appears during fast forwarding, and **◀◀** appears during rewinding.
- **||** appears during record pause.
- *A/V DUB* appears during audio/video dubbing.

⑤ Time Counter With Memory Stop



- The counter shows the amount of elapsed recording or playback time.
- Press *DISPLAY* on the remote to turn memory stop on or off. An *M* appears with the time counter when memory stop is turned on.

Note: During playback or play pause, you can press *DISPLAY* on the camcorder to turn memory stop on and off.
- *Details are on page 35.*

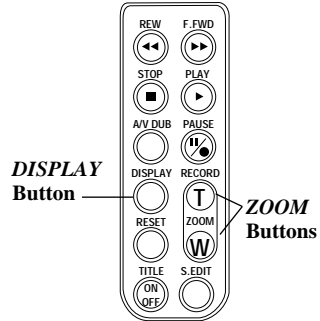
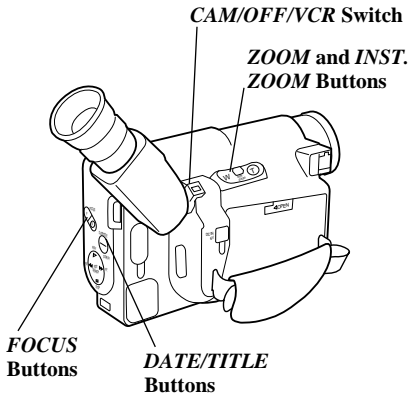
Displays in Viewfinder



6 Time Remaining

-   displays the amount of recording or playback time left on the cassette in the camcorder.
- *Details are on page 24.*

7 Battery Level Indicator

- This indicator shows the amount of time left for the rechargeable battery (or alkaline “AA” batteries).
- *Details are on page 17.*

8 TAPE, NO TAPE, and TAPE END

- **TAPE** flashes when you try to record and the safety tab has been closed.
- **TAPE** flashes when a tape is inserted in the camcorder and moisture is present or the tape is damaged. Moisture may develop when the camcorder is moved from a cold area to a warm area. Remove the tape and wait an hour before reinserting. If the tape is damaged, remove the tape and replace it.

- **NO TAPE** flashes when you try to record and there is no cassette in the camcorder.
- **TAPE END** flashes when there is approximately three minutes of recording time left on the cassette.
- **TAPE END** appears briefly during recording when the end of the cassette is reached.

9 Time and Date

Press **DATE/TITLE** repeatedly to display the time and date, auto date, auto title, or date only when the camcorder is in record or record pause.

- These displays will be recorded on the tape whenever they appear in the viewfinder.
- *Details are on pages 26-27.*

Focusing Your Camcorder

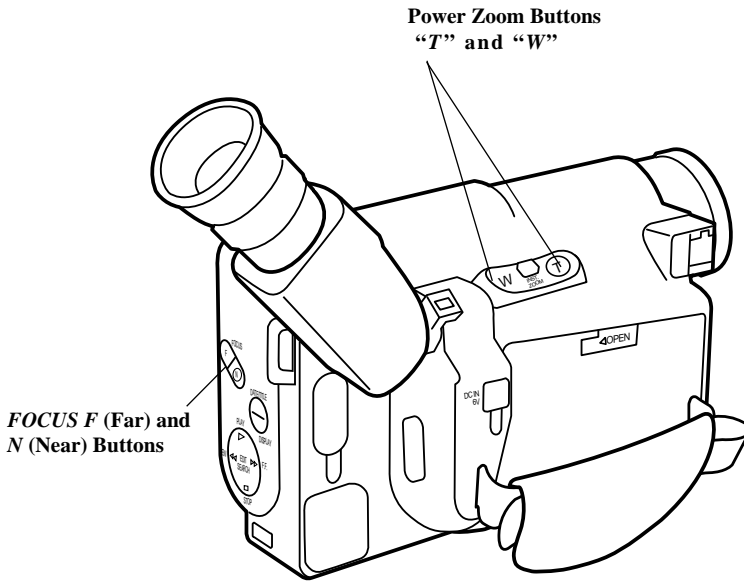

Auto Focus

The camcorder will focus automatically whenever *FOCUS* does not appear in the viewfinder.

- If *FOCUS* appears, press *FOCUS F* and *N* at the same time to turn on auto focus.

The camcorder will automatically focus on the subject in the center of the viewfinder.

Auto focus will operate on the telephoto "T" side from approximately 3.3 feet to infinity.

Auto focus will operate on the wide-angle "W" side 3/8 inches from the lens surface to infinity.

Focusing Your Camcorder

Manual Focus

Under certain conditions, such as those listed, you may need to focus manually.

1. Press *FOCUS F* and *N* at the same time to turn on manual focus. *FOCUS* appears in the viewfinder.
2. Press zoom button *T* to zoom in on your subject.

To maintain proper focus throughout the zoom range, zoom in on your subject before adjusting the focus.

3. Press and hold either *FOCUS* button until the subject is clearly focused.
4. When you are finished, Press *FOCUS F* and *N* at the same time to turn on auto focus. *FOCUS* disappears from the viewfinder.

Conditions that May Require Manual Focus

The following conditions may require the use of manual focusing during recording.

- When a subject has a close foreground and a background far away.
- When two subjects at different distances overlap.
- A subject with distinct horizontal stripes or small pattern.
- A subject not in the center of the viewfinder.
- Subjects with shiny surfaces or sharp angles.
- Recording in low-light situations.
- Recording through a window.

Macro Focus

The macro-focus feature lets you focus on objects as close as 3/8 inch from the camcorder lens.

1. Make sure *FOCUS* does not appear in the viewfinder. If it does, press *FOCUS F* and *N* at the same time to remove it.
2. Press and hold zoom button “*W*” until the lens is completely zoomed out.
3. Position the subject in the center of the viewfinder.

Notes: Zooming is not possible when using macro focus. To change the size of the subject, move the camcorder’s lens closer or farther away from it.

For best results, increase illumination when recording using macro focus.

Zooming

The motorized zoom lens allows you to zoom in (enlarge the image from 1-12 times) for close-ups or out for wide-angle shots.

Digital zoom lets you zoom in on a subject with magnification up to 24 times.

Instant zoom lets you magnify the picture 1.5 times regardless of the position of the zoom buttons.

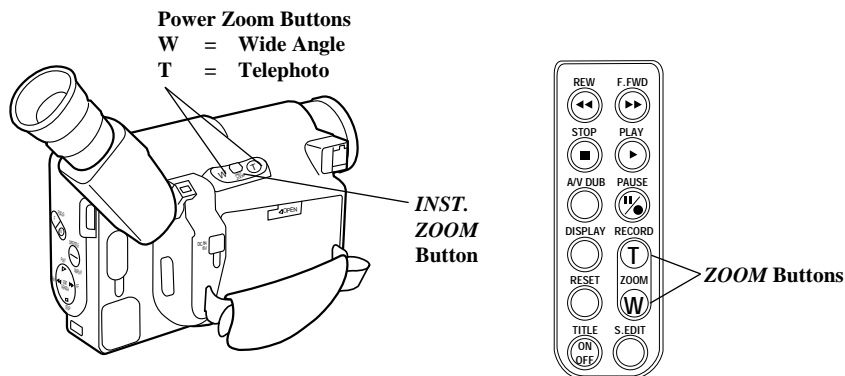

Using Power Zoom Buttons

- Press “W” to move the lens in the wide-angle direction.
- Press “T” to move the lens in the telephoto (close-up) direction.

The zoom level indicator appears briefly in the viewfinder.

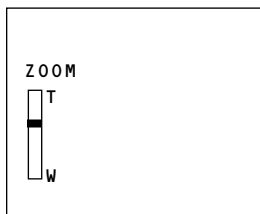

When the zoom ratio goes above twelve times, *ZOOM* appears in the viewfinder.

Note: Some deterioration of the picture may occur with zoom ratios above twelve.

Using *INST.* (Instant) *ZOOM* Button

- Press *INST. ZOOM* to magnify the subject 1.5 times regardless of the position of the power zoom buttons.
- Press *INST. ZOOM* again to turn off instant zoom.
- *I. ZOOM* appears in the viewfinder during instant zoom.

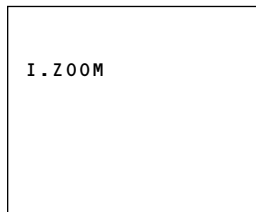

Note: Some deterioration of the picture may occur when using instant zoom.

Time Counter With Memory Stop

The time counter shows actual time elapsed when recording or playing back a tape. It quickly locates the end of recorded segments.

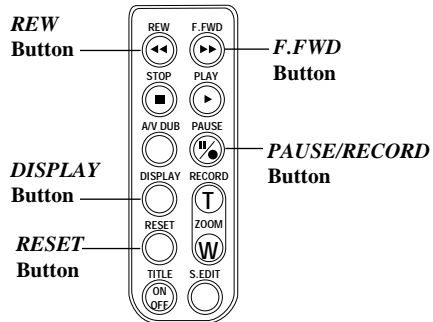
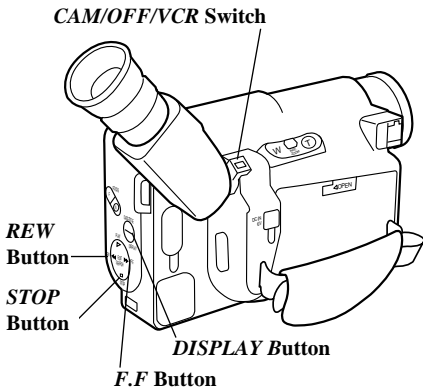

To Use Time Counter

For example, you recorded a 10-minute segment. Later, you want to locate the end of your recording. Insert the cassette and fast-forward the tape until the time counter reads “0:10:00”.

Memory-Stop Feature

The memory-stop feature helps you locate a certain point on the tape. When memory stop is turned on, the tape will stop automatically during rewind or fast forward when the time counter reaches “0:00:00M”.

1. Press *DISPLAY* on the remote to turn on memory stop. An “M” appears behind the time counter.

Note: During playback or play pause, you can also press *DISPLAY* on the camcorder to turn memory stop on and off.

2. Locate the place on the tape you want to return to and press *RESET* on the remote to set the time counter to “0:00:00M”.

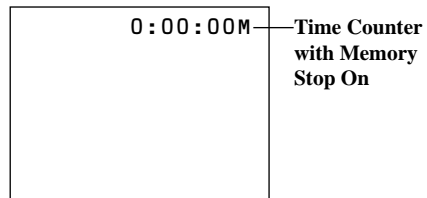

3. Continue to record or play the tape.

When you want to return to the place you marked, press the thumb trigger on the camcorder (or *PAUSE/RECORD* on the remote) to stop recording or the *STOP* button to stop playing back the tape.

4. Make sure the *CAM/OFF/VCR* switch is in *VCR*, and then press *REW*. The tape will rewind to the time counter reading of “0:00:00M”.

Notes: If you rewind the tape farther back than a counter reading of “0:00:00”, a minus will appear in front of the counter.

The time counter is automatically reset to “0:00:00” each time a cassette is inserted.

Titler

The titler can store a title page in memory that can be displayed and recorded at any time. The built-in character register contains 47 characters for creating titles on two lines with up to 16 characters per line.

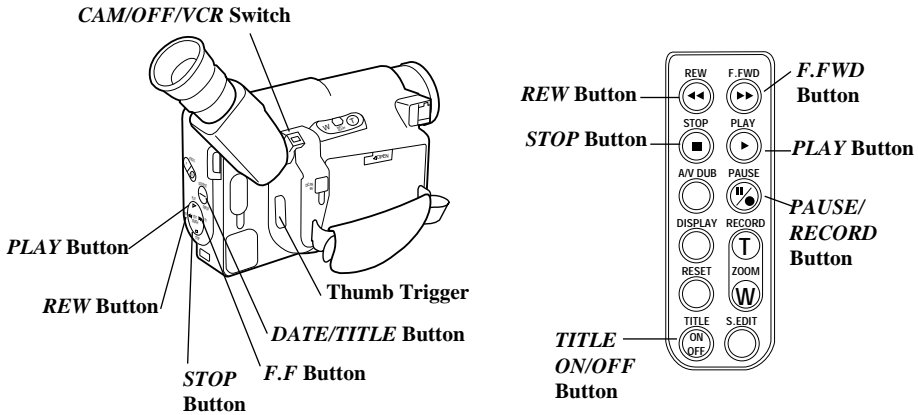

Creating a Title

1. Attach a power source and slide the *CAM/OFF/VCR* switch to *CAM* or *VCR*.
2. Press *TITLE ON/OFF* on the remote to display the title graphics.
Note: If the *CAM/OFF/VCR* switch is in *CAM*, pressing *DATE/TITLE* on the camcorder will also display the title page.
3. Press *STOP* to move the flashing cursor to the place you want to begin.
4. Select the first character by pressing *F.F* (*F.FWD* on remote) or *REW* until the character you want appears. See the "Chart of Characters" on the next page for the characters available in the titler's register.
5. After you have selected the first character, press *STOP* to move the flashing cursor to next position.

6. Repeat steps 4 and 5 until you have completed the title.

Note: To correct a character, press *STOP* to place the cursor over it and then press *F.F* (*F.FWD* on remote) or *REW* to enter the correct character.

If you want to delete a character, press *F.F* (*F.FWD* on remote) or *REW* until the blank space appears.

7. Press *TITLE ON/OFF* on remote to store the title and remove the title display from the viewfinder when you are finished.

Important Note: Remember to remove the title graphics from the viewfinder for normal recording.

Titler

Chart of Characters in Titler's Register

A	B	C	D	E	F	G	H	I	J	K	L	M
N	O	P	Q	R	S	T	U	V	W	X	Y	Z
0	1	2	3	4	5	6	7	8	9			
? ' . / , - ; : < > ! (Blank Space)												

Recording Titles on a Tape in the Camcorder

1. Attach a power source and slide *CAM/OFF/VCR* to *CAM*.
2. Locate the place on the tape where you want to record the title.
Note If you record a title on a pre-recorded tape, the audio and video will be erased where the title is inserted. There will also be a three-to-four second pause of blank tape before the existing audio and video return.
3. Place the camcorder in record pause.
4. Press *TITLE ON/OFF* on remote to display the title in viewfinder.
5. Press the thumb trigger (*PAUSE/RECORD* on remote) to start recording the title.
6. Press *TITLE ON/OFF* on remote to remove the titler graphics from the viewfinder. The camcorder will now record as normal. If you do not want to continue recording, press the thumb trigger (*PAUSE/RECORD* on remote) to stop recording.

Note: You can also use the *AUTO TITLE* feature to automatically record the title and date for ten seconds when you begin recording. Press *DATE/TITLE* to display  *TITLE* before starting to record.

Recording Titles While Copying a Tape on Another VCR

1. Connect the camcorder to a VCR as shown on pages 50-51.
2. Attach a power source and slide *CAM/OFF/VCR* to *VCR*.
3. The title will appear when you press *TITLE ON/OFF* on the remote.
4. Press *TITLE ON/OFF* on remote to remove the title from the viewfinder.
5. Insert the cassette you want to copy into the camcorder and a blank cassette with safety tab into the VCR.
6. Start VCR recording and camcorder playing.
7. When you see the place on the tape where you want to record the title, press *TITLE ON/OFF* on remote to display the title in the viewfinder.
8. When you are finished recording the title, press *TITLE ON/OFF* on remote to remove the title from the viewfinder.

Audio/Video Dubbing

A/V (audio/video) *DUB* on the remote lets you record new audio and video from another VCR or camcorder to a previously recorded tape in the camcorder. You will need an optional VAA009 audio/video input cable shown on page 57.

Notes: The source for audio and video when dubbing is the signal coming through the audio and video plugs of the audio/video input cable.

If you connect only the video plug of the audio/video input cable to the VCR, you will have no sound on the dubbed portion.

If you connect only the audio plug of the audio/video input cable to the VCR, the camcorder will not dub.

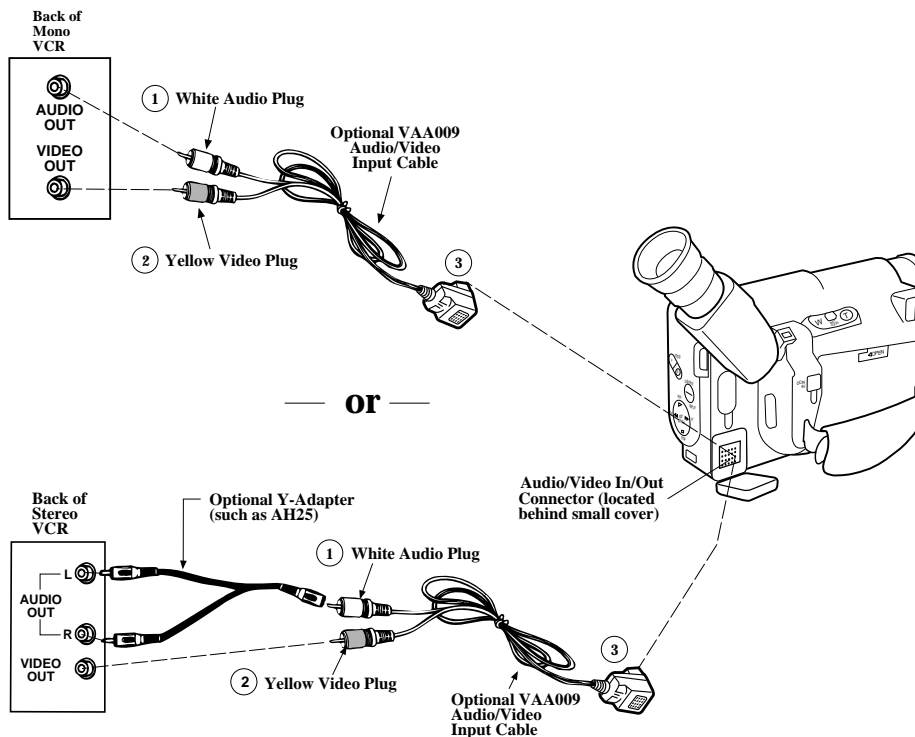

Installation

- ① Attach the input cable's white plug to the *AUDIO OUT* jack of the VCR.
Note: If your VCR has left and right stereo *AUDIO OUT* jacks, attach the plug to the one labeled *MONO*. If one is not *MONO*, you may need a Y-adapter to record both channels.
- ② Attach the input cable's yellow plug to the *VIDEO OUT* jack on the VCR.
- ③ Attach the plug on the other end of the input cable to the audio/video in/out connector located behind the small cover on the side of the camcorder. (Match the tabs on the plug with the notches on the camcorder connector. Do not force the plug.)

Audio/Video Dubbing

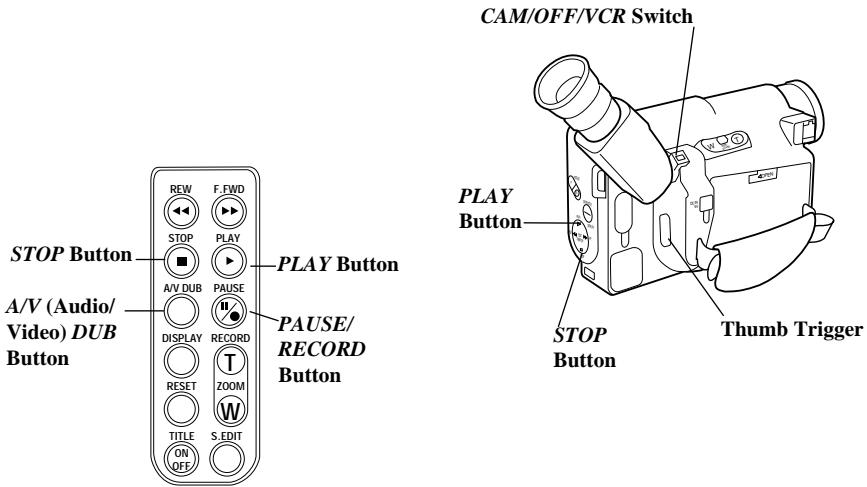

To Audio/Video Dub on the Camcorder

1. Slide camcorder's *CAM/OFF/VCR* switch to *VCR*.
2. Insert the tape you want to dub on, press *PLAY*, and locate a place on the tape a few seconds before where you want the dubbing to begin.
3. Place the camcorder in play pause exactly where you want to begin dubbing using the thumb trigger (*PAUSE/RECORD* on remote).
4. Press and hold *A/V DUB* on remote, and then press *PLAY* to place the camcorder in AV dub pause. *A/V DUB* ■■ appears in viewfinder.
5. Place the tape you want to dub from in the *VCR*, locate the beginning of the part you want to dub, and place the *VCR* in play pause.
6. Start the *VCR* playing and press the thumb trigger (*PAUSE/RECORD* on remote) to start dubbing.
7. Press *STOP* when you want the dubbing to stop.

■■ disappears and *A/V DUB* remains in viewfinder.

Notes: If you want to stop dubbing at a certain point on the tape, turn on the camcorder's memory-stop feature. Set the time counter to "0:00:00M" at the point where you want the dubbing to stop. The camcorder will automatically stop dubbing when it reaches "0:00:00M".

You can record new audio and video from the camcorder's built-in microphone and camera. Remove the input cable from the camcorder. Follow steps 1 through 4 above, and then press thumb trigger (*PAUSE/RECORD* on remote) to start dubbing. To stop dubbing, press *STOP*.

The camcorder will automatically enter the stop mode to prevent excessive tape wear if it remains in dub pause for more than five minutes.

Synchro Edit

Synchro edit allows your camcorder to control a VCR (one that has a compatible *PAUSE*, *EDIT*, *EDIT IN/OUT*, or *SYNC* jack) while tapes are being copied from the camcorder to the VCR. This is convenient when you want to copy only selected segments from a previously recorded tape. An optional AVS80 synchro edit cable *shown on page 57* is required.

Note: *Not* all RCA VCRs have compatible synchro edit jacks.

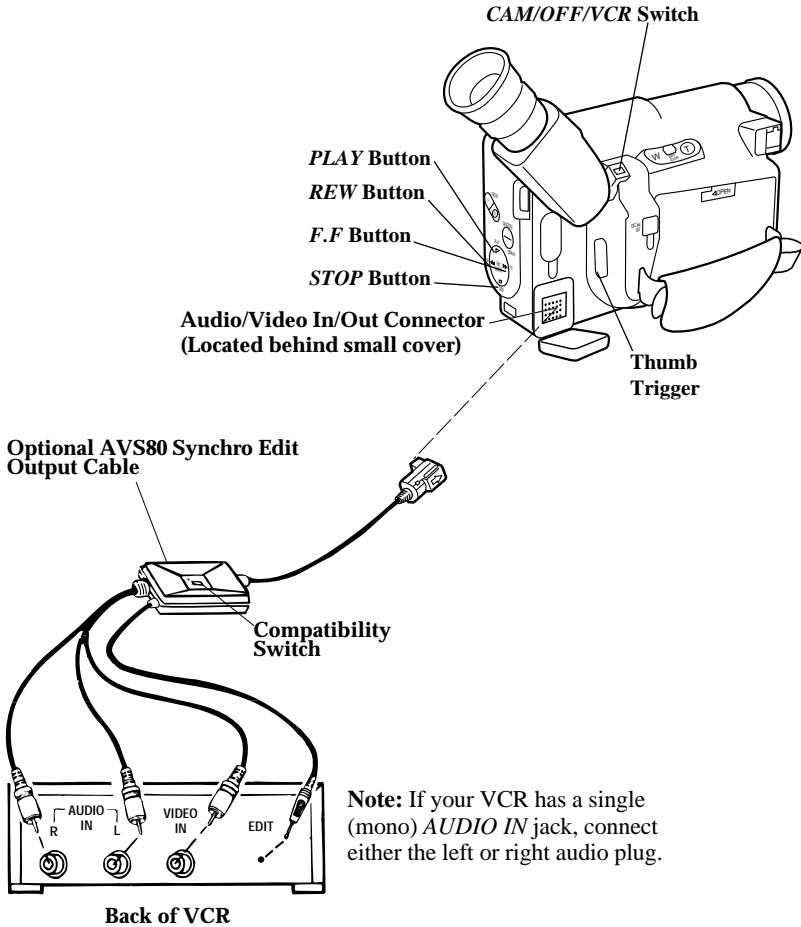

Caution: The unauthorized recording of copyrighted material may infringe the rights of others. Such recordings should not be made.

Synchro Edit

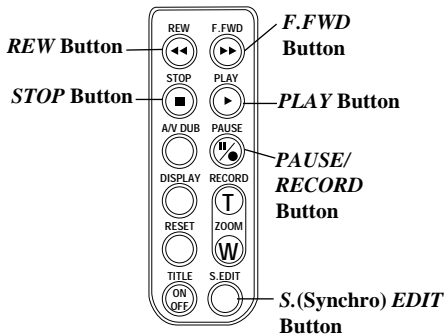

To Synchro Edit

1. Connect your camcorder to a compatible VCR *as shown*.
2. Prepare the camcorder to play back the tape you want to copy.
 - Slide the *CAM/OFF/VCR* switch to *VCR*.
 - Insert the tape you want to copy.
 - Press *PLAY*.
 - Press the thumb trigger (*PAUSE/RECORD* on remote) to place the camcorder in play pause.
3. Prepare the VCR to record.
 - Turn on the VCR.
 - Insert a blank tape into VCR.
 - Press *RECORD* to put VCR in record pause.

Note: If the VCR begins to record instead of pausing – stop the VCR, change the compatibility switch on the AVS80 cable, and press *RECORD* on the VCR again.
4. Press *S.EDIT* on the remote to start the camcorder playing and the VCR recording.

Note: Pressing *S.EDIT* puts the camcorder in review for several seconds and then into playback.
5. Pressing *REW*, *F.FWD*, *STOP*, or thumb trigger (*PAUSE/RECORD* on remote) automatically puts the VCR into record pause. This allows you to search (forward or backward) or fast-forward or rewind the tape in the camcorder without disturbing the tape in the VCR.
 - To search forward (or backward), press *F.F* (*F.FWD* on remote) or *REW*. Press *PLAY* to resume normal playback. To begin copying again, press the thumb trigger (*PAUSE/RECORD* on remote) and then press *S.EDIT* on remote.
 - To fast-forward or rewind the tape, press *STOP* then *F.F* (*F.FWD* on remote) or *REW*. To begin copying again, press *STOP*, then *PLAY*, then the thumb trigger (*PAUSE/RECORD* on remote). Then press *S.EDIT* on remote to begin copying.
6. If you want to stop copying the tape at a certain point, turn on the camcorder's memory-stop feature, and set the camcorder's time counter to "0:00:00M" at the point on the tape where you want to stop copying. When the camcorder reaches "0:00:00M" on the tape, it will automatically place the VCR in record pause.

Recording from VCR or TV Monitor

To connect your camcorder to a TV (or VCR) with *AUDIO* and *VIDEO OUT* jacks, you will need an optional VAA009 audio/video input cable shown on page 57. If your TV is already connected to a VCR, you can attach the camcorder to the VCR and watch what the camcorder is recording on the TV.

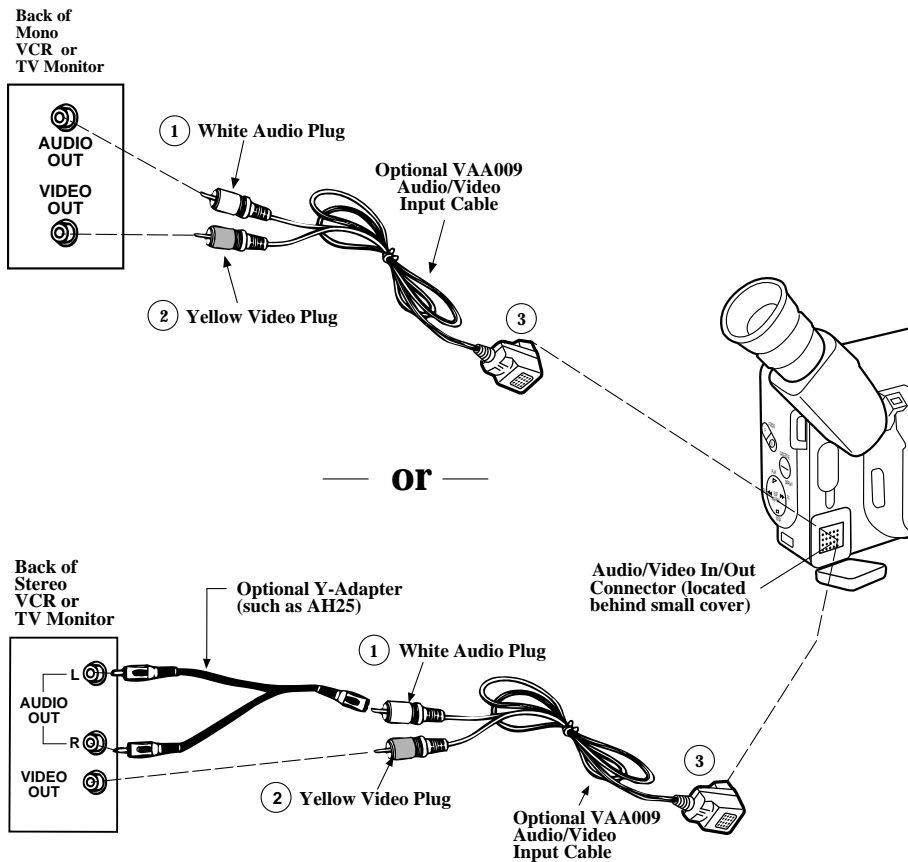

Recording from VCR or TV Monitor

Installation

- ① Attach the audio/video input cable's white plug to the *AUDIO OUT* jack on the TV or VCR.
Note: If your TV or VCR has stereo left and right *AUDIO OUT* jacks, attach the plug to the one labeled *MONO*. If one is not labeled *MONO*, you may need a Y-adaptor to record both channels.
- ② Attach the audio/video input cable's yellow plug to the *VIDEO OUT* jack on the TV or VCR.
- ③ Attach the plug on the other end of the audio/video input cable to the audio/video in/out connector behind the small cover on the side of the camcorder.
(Match the tabs on the plug with the notches on the camcorder connector. Do not force the plug.)

How to Record from a Monitor TV (or VCR)

1. A. Camcorder connected directly to TV monitor: Turn on the TV and tune it to the channel you want to record.
B. Camcorder connected to a VCR that is already connected to a TV: Turn on VCR and select channel you want to record, or place the cassette you want to copy in the VCR. If you are copying a tape, press the *PLAY* button on the VCR.
Note: If you want to see what is being recorded, turn on the TV, and tune it to the channel you normally use to see the signal from the VCR.
2. Slide the camcorder's *CAM/OFF/VCR* switch to *CAM*, and insert a blank cassette. Press the camcorder's thumb trigger (*PAUSE/RECORD* on remote) to start recording.
3. Press the thumb trigger (*PAUSE/RECORD* on remote) when you are finished.

Caution: The unauthorized recording of television programs and other materials may infringe the rights of others.

Optional Color Enhancement Light

An optional VLP04 color enhancement light *shown on page 55* helps create brighter, sharper pictures in very low light conditions. It lights subjects in darkened areas or corrects unflattering shadows.

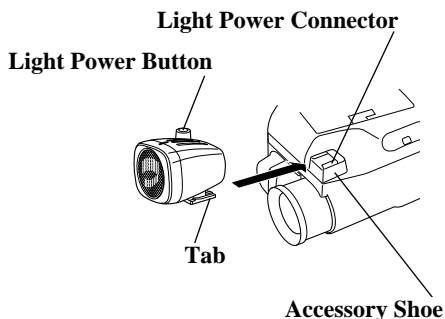

Caution: Do not touch the light power connector when the camcorder is on.

1. Attach the rechargeable battery or AC adapter/charger to power the camcorder.
2. Make sure the camcorder is turned off. Then attach the light to the light power connector and accessory shoe *as shown above*.
3. Press and hold the small button on the **CAM/OFF/VCR** switch while placing it in **CAM**.
4. Turn on the light by pressing the power button on the light.
Note: Press the button again to turn off the light.
5. To remove the light from the camcorder, depress the light and release the tab from the accessory shoe. Then slide the light off the camcorder.

Notes: Turn on the light only when needed. The power consumption of the light is much more than that of the camcorder. When the light is turned on, the operation time of the rechargeable battery is reduced by more than half.

Avoid bumping or shaking the light when in use. The light's bulb is sensitive when hot and may burn out.

Do not allow water to drop on the light when in operation.

Do not touch the bulb with your fingers. It may shorten its service life.

Make sure the front case of the light is properly attached after removing it or replacing a bulb.

Optional Color Enhancement Light

Cautions: After using the light, be sure to allow it sufficient time to cool down completely.

Use only bulb (VLB04) when replacing the bulb to reduce the risk of fire or other hazards.

Do not use the light when powering your camcorder with the optional car cord adapter because the car cord will become very hot.

Dangers: During operation and after using the light, the front surface and bulb of the light will be very hot. To avoid burns, do not touch them.

To prevent overheating, do not block or cover the ventilation holes on the color enhancement light.

Never use the light in the vicinity of explosives or highly flammable materials.

Removing and Replacing the Light Bulb

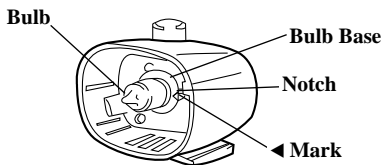
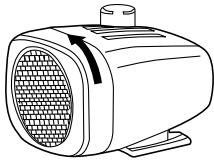

1. Turn the case front counterclockwise to remove it.

2. Remove the bulb by pulling it out through the open case.

3. Hold the new bulb with a soft cloth and align the notch in the rim of the bulb's base with the ◀ mark outside the socket.

Note: When replacing the light's bulb, use only Stock #VLB04 to reduce the risk of fire and other hazards. See the installation instructions packed with the replacement bulb when replacing the bulb.

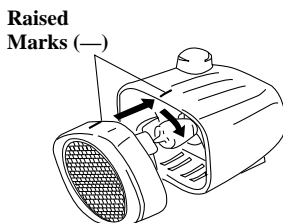

4. Reattach the case front by placing the bulb in the hole of the reflective plate, lining up the smaller raised mark (—) on the front of the cover with the raised mark (—) on the light's case. Then turn the front clockwise until the larger raised mark (—) on the front cover aligns with the mark on the case.

Attaching the Shoulder Strap

The shoulder strap packed with your camcorder is designed to let you carry the camcorder from your shoulder and – when you are ready to shoot – bring the camcorder to shooting position in one quick movement.

To Attach the Shoulder Strap

1. Thread each end of the strap through one of the attachment rings *as shown below*.

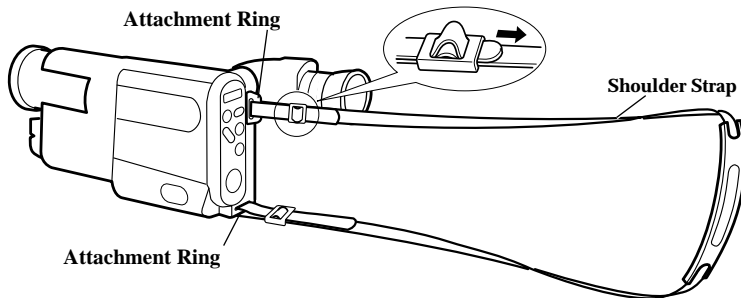

2. Thread each end of the strap back into its buckle. Pull on the strap and make sure it is securely fastened before using the shoulder strap to support the camcorder.

Caution: When carrying the camcorder with the shoulder strap, you may find it convenient to rotate the viewfinder down. This helps prevent possible damage to the viewfinder from bumping against your body as you move.

Removing the Lens Hood

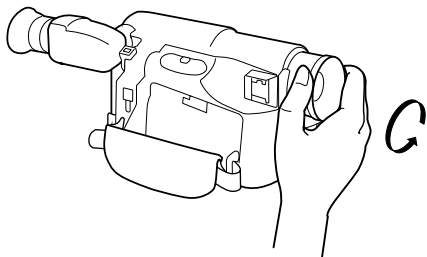

The lens hood can be removed so you can attach optional accessories.* To remove the lens hood, turn it counterclockwise.

*Optional accessories may be available from camera shops and electronic supply stores.

Camcorder Recording and Traveling Tips

- Do not bump or tap the microphone while recording – this sound will be recorded. Be aware of backgrounds. Background details may show up as visual “clutter”. Noises (especially TV sets, household appliances, traffic, etc.) can detract from the sound you record.
- Avoid long “still” shots of landmarks and scenic attractions. Include people and details. “Local color” gives travel videos lasting appeal. Consider recording a familiar or landmark scene from an unfamiliar vantage point.
- Try to make sure indoor scenes are well-lit. This improves picture quality and color reproduction.
- Practice recording under a variety of lighting conditions.
- Use the viewfinder to keep camcorder level or scenes will appear “tilted”.
- Include close-up shots of individuals when taping family outings or group functions.
- Make a video recording of your home and contents to store in a safe place in case of fire or theft.
- Do not move the camcorder rapidly from side-to-side while recording. A steady, gradual “pan” avoids blurring and “jitter”.

Holding The Camcorder

- To film at different angles, raise the viewfinder.
- Standing against a wall may give your recordings more stability.
- Use an optional tripod for stable images.
- Hold the camcorder horizontally. Keep your feet slightly apart and upper arms close to your body.
- When possible, rest your elbows on a table or other stable surface to help keep the camcorder steady.
- Do not pick up the camcorder by the viewfinder.

Traveling Tips

- Write down your camcorder’s serial number and keep it separate from the camcorder when traveling. If your camcorder is lost or stolen, you will be able to identify it.
- Use extra care to avoid damage to your camcorder and accessories when operating them at a beach or pool. Spray, sand, and dust should be avoided. If your lens has been exposed to the elements, clean it only with proper lens cleaning supplies.
- Carry your camcorder in a carrying case when traveling. *See page 55* for a case especially designed for this camcorder. An ordinary suitcase or carry bag does not offer the protection your camcorder needs. Treat your camcorder as carry-on luggage to protect it from rough handling.

Viewfinder Playback and Playback Features

Viewfinder Playback

Viewfinder playback is the simplest way to watch tapes using the camcorder. This method is generally used only to review scenes immediately after recording.

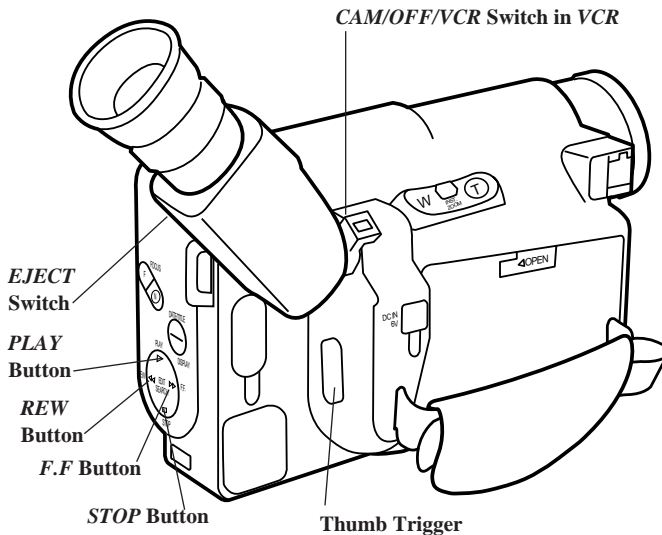

To Play Back a Tape Through the Viewfinder

1. Press and hold the small button on the *CAM/OFF/VCR* switch while sliding it in *VCR*.
2. Insert the cassette you want to play.
3. Press the *PLAY* button.
4. Press the *STOP* button when you are finished.

Viewfinder Playback and Playback Features

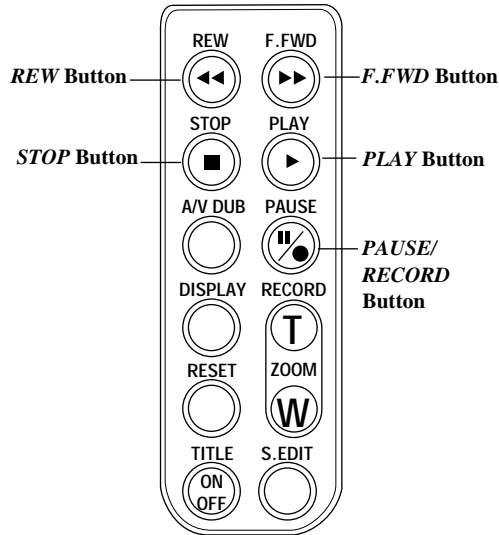

Playback Features

Stop-Action Pause

- During playback, press the thumb trigger (*PAUSE/RECORD* on remote) to “stop the action” and view one frame of the tape.

Caution: Pause is designed for momentary interruptions and should not be used for an extended period of time. If the camcorder remains in pause for more than five minutes, it will move the tape away from the spinning heads to prevent excessive tape wear.

- Press the thumb trigger (*PAUSE/RECORD* on remote) again to return to normal playback.

Visual Searching

- During playback, press and hold *F.F* (*F.FWD* on remote) or *REW* if you want to visually search the tape in forward or reverse.
- Release the button to return to normal playback.

Notes: During pause and search operations, it is normal for streaks to appear in the picture.

The sound is muted during special playback operations.

Playback on TV or VCR Using *AUDIO/VIDEO IN* Jacks

To connect your camcorder to a TV or VCR using *AUDIO/VIDEO IN* jacks, use the audio/video cable that was packed with the camcorder. If your TV is already connected to a VCR, you can attach the camcorder to the VCR and watch what the camcorder is recording or playing on the TV.

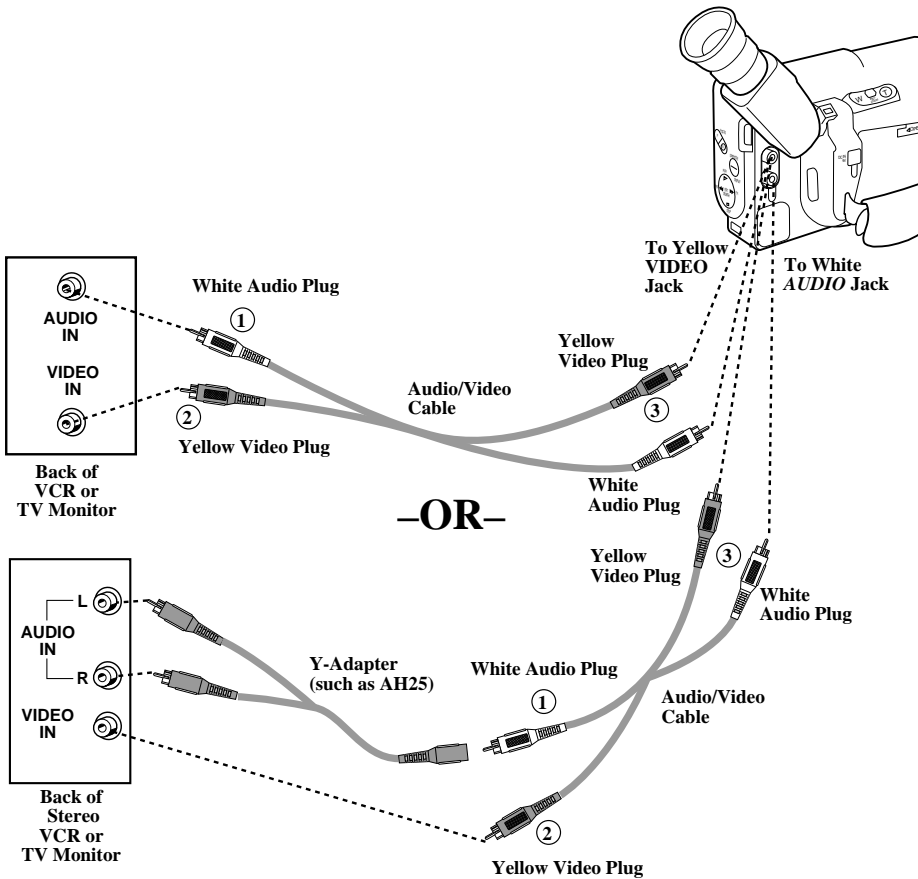

Playback on TV or VCR

Installation

- 1 Attach the white plug on the audio/video cable to the *AUDIO IN* jack on the TV or VCR.

Note: If your TV or VCR has stereo *AUDIO* jacks, attach the *AUDIO* plug to the one labeled *MONO*. If one is not labeled *MONO*, you may need a Y-adaptor to hear sound from both channels.

- 2 Attach the yellow video plug on the same end of the audio/video cable to the *VIDEO IN* jack on the TV or VCR.
- 3 Attach the yellow plug on the other end of the audio/video cable to the yellow *VIDEO* jack and the white plug to the white *AUDIO* jack located behind the small cover on the side of the camcorder.

Playback Operation and How to Copy Tapes on the VCR

1. A. Camcorder connected directly to TV monitor: Turn on the TV and tune it to the video input channel.
B. Camcorder connected to VCR that is already connected to TV: Turn on VCR and place it in the “line” or “camera mode”. (If your VCR does not have a “line” or “camera mode”, consult the VCR owner’s manual.) Operate the TV as you normally do to see the signal coming from the VCR.
2. Attach a power supply and place the camcorder’s *CAM/OFF/VCR* switch in *VCR*. Insert the cassette you want to playback.
3. Press *PLAY* to begin playback.
During playback, use the features on page 49.
4. To copy what the camcorder is playing, place a blank cassette in the VCR and start it recording.
5. Press *STOP* when you are finished.

Notes: The corresponding buttons on the remote control will operate the camcorder.

Caution: The unauthorized recording of television programs and other recorded material may infringe the rights of others.

Viewing What the Camcorder is Seeing (or Recording)

1. A. Camcorder connected directly to TV: Turn on the TV, and tune it to the video input channel.
B. Camcorder connected to VCR that is already connected to TV: Turn on VCR and place it in the “line” or “camera mode”. (If your VCR does not have a “line” or “camera mode”, consult the VCR owner’s manual.) Operate the TV as you normally do to see the signal coming from the VCR.
2. Attach a power supply and slide the camcorder’s *CAM/OFF/VCR* switch in *CAM*. Insert a cassette if you want to record.
Note: When the camcorder is used as a camera, turn the TV’s volume down to prevent a high-pitched squeal caused by feedback.
3. Press the camcorder’s thumb trigger (*PAUSE/RECORD* on remote) to begin recording. You can watch what the camcorder is seeing (or recording) on the TV screen.

Playback on TV without Audio/Video Inputs

To connect your camcorder to a TV without audio and video inputs, you need an optional RF output adapter, such as CRF81 shown on page 57.

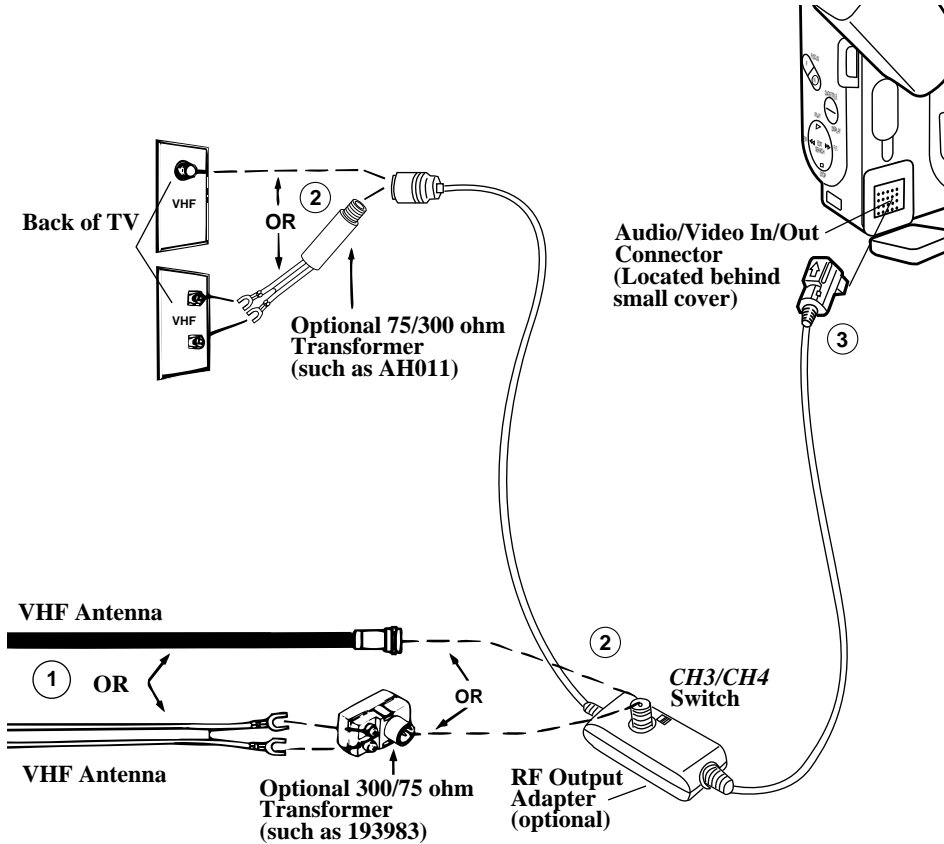

Installation

- 1 Disconnect the VHF antenna from your TV. Connect the antenna to the *ANT IN* connector on the RF output adapter if you leave the adapter connected to the TV.

Note: If your VHF antenna is the flat twin-lead type attached by two screws, you will need an optional 300-75 ohm transformer, such as 193983.

- 2 Attach the RF output adapter's cable to the VHF input on your TV.

Note: If your TV has 300 ohm VHF screw terminals, you will need an optional 75-300 ohm transformer, such as AH011.

- 3 Attach the RF output adapter's plug to the audio/video in/out connector under the small cover on the side of the camcorder.

Playback on TV without Audio/Video Inputs

Playback Operation

1. Set the *CH3/CH4* switch on the RF output adapter to *CH3* or *CH4*.
2. Turn on the TV, and tune it to channel 3 or 4 – the same channel you selected with the *CH3/CH4* switch.
3. Attach a power supply, and place the camcorder's *CAM/OFF/VCR* switch in *VCR*. Insert the cassette you want to play back.
4. Press *PLAY* to begin playback.
During playback, use the features on page 49.
5. Press *STOP* when you are finished.

Note: The corresponding buttons on the remote control will operate the camcorder.

Viewing What the Camcorder Is Recording

1. Turn on the TV and tune it to channel 3 or 4.
Note: When the camcorder is used as a camera, turn the TV's volume down to prevent a high-pitched squeal caused by feedback.
2. Set the *CH3/CH4* switch on the RF output adapter to the same channel you selected on the TV.
3. Attach a power supply and place the camcorder's *CAM/OFF/VCR* switch in *CAM*. Insert the cassette you want to record on.
4. Press the thumb trigger on the camcorder (*PAUSE/RECORD* on remote) to start recording. You can watch what you are recording on the TV screen.

Normal TV Viewing

You can leave the RF output adapter hooked up to the TV. Disconnect the adapter's plug from the camcorder or turn off the camcorder's power.

Note to Cable TV Installer

This reminder is provided to call your attention to Article 820-40 of the National Electrical Code (Section 54 of Canadian Electrical Code, Part I), that provides guidelines for proper grounding and, in particular, specifies that the cable ground shall be connected to the grounding system of the building as close to the point of cable entry as practical.

Care and Maintenance

- Keep dust and grit from entering the cassette door. They are abrasive and cause excessive wear both to the camcorder's recording/playback heads and cassettes.
- Always replace the lens cap on the lens when the camcorder is not in use.
- When the camcorder is not in use, always remove the cassette and AC adapter/charger or battery.
- The camcorder can be damaged by improper storage or handling. Do not subject the camcorder to swinging, shaking, or dropping.
- Do not touch the lens with your fingers. The oil from your skin can damage the lens. Use lens-cleaning tissue and commercially prepared cleaning solution designed for use on camera lens. Improper cleaning may scratch the lens.
- Before handling your camcorder, make sure your hands and face are free from any chemical products such as suntan lotion, as it may damage the finish.
- Do not operate the camcorder for extended periods in temperatures below 40°F (4°C) or above 95°F (35°C). Do not store the camcorder in temperatures below -22°F (-30°C) or above 149°F (65°C).
- Do not operate the camcorder in extremely humid environments.
- Do not aim your camcorder at the sun or other bright objects.
- Do not leave your camcorder in direct sunlight. Doing so could permanently damage the camcorder's internal parts.

Cleaning the Viewfinder

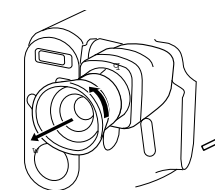

1. Rotate the eyepiece counterclockwise until it stops and remove it.

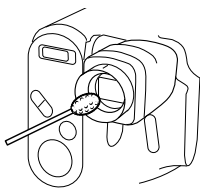

2. Use a soft non-abrasive cloth, swab, or lens cleaning paper to clean the miniature monitor.



3. Insert the eyepiece with the raised mark (—) at the center of the viewfinder. Then rotate the eyepiece clockwise until it stops.

Optional Accessories

We invite you to take a look at some great ideas for sparking creativity and adding to the fun of using your 8mm camcorder. These pages have a selection of accessories to help make your memorable moments look and sound even better.

These accessories are designed to make the process of recording and watching your videos more enjoyable.

To order accessories, contact your local Dealer.

If a dealer is not nearby, all accessories are available through toll-free ordering or by using the order form *on page 59*.

AC025A Soft Carrying Case

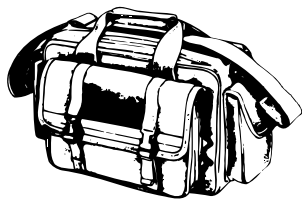

Custom compact soft case designed especially to provide protection and utility for your 8mm camcorder and most accessories. Rugged fabric lined with soft non-abrasive material and generous padding. Has three outside pockets with storage for lens filters, adapters, batteries, and tapes.

VLP04 Color Enhancement Light

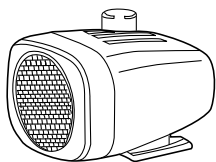

The VLP04 helps create brighter, sharper pictures in very low light conditions. It lights subjects in darkened areas or corrects unflattering shadows. Uses VLB04 replacement bulb.

VCC1000 Video Color Control Center

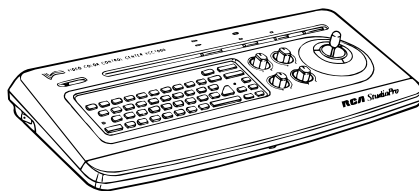

The VCC1000 is two accessories in one. The color control center allows you to adjust the color intensity, tint, white balance, and sharpness of tapes being dubbed. This is especially helpful when the original tape was produced in poor lighting conditions or poor color settings. The second feature – the character generator – lets you create titles that can be recorded on your tapes. This lets you add a professional and/or personal touch to your home videos.

All specifications and descriptions of accessories are subject to change without notice.

Optional Accessories

DCC80 Car Cord Adapter/Charger

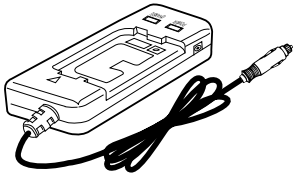

Caution: Do not use any other car cord adapter/charger with this camcorder.

This car cord adapter/charger enables you to operate your camcorder from your car, truck, or RV by plugging it into the vehicle's cigarette lighter socket. It will also charge the BV060 battery supplied with your camcorder or the BB150 battery.

The DCC80 is specially designed to convert power from a 24-volt or 12-volt battery to a 6-volt output. The vehicle does not have to be turned on for the DCC80 to operate the camcorder.

DCC06 Car Cord Adapter

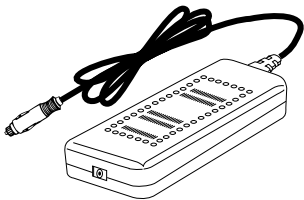

Caution: Do not use any other car cord adapter with this camcorder.

This car cord adapter enables you to operate your camcorder from your car, truck, or RV by plugging it into the vehicle's cigarette lighter socket. The DCC06 is specially designed to convert power from a 24-volt or 12-volt battery to a 6-volt output. The vehicle does not have to be turned on for the DCC06 to operate the camcorder.

CPS85 AC Battery Charger

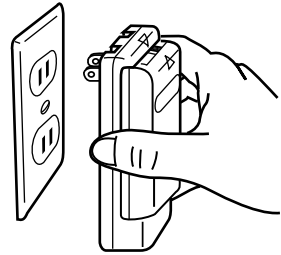

The CPS85 battery charger plugs directly into an AC outlet, and charges the BV060 and BB150 camcorder batteries. Because the CPS85 operates on 100-240 volts, 50/60 Hz, it can be used virtually anywhere in the world. A plug adapter may be required in some countries. Charging takes approximately 5 hours for the BV060 (1-hour) battery or 7 hours for the BB150 (1.4-hour) battery.

Rechargeable Batteries

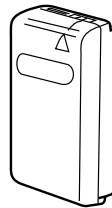

BV060

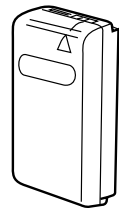

BB150

These rechargeable nickel-cadmium batteries are specifically designed for long life. The BV060 can power your camcorder up to 1 hour, and the BB150 up to 1.4 hours (depending on how much you use zoom and pause). Both can be recharged with the AC adapter/charger that came with your camcorder. Initial charging and recharging takes about 1 hour for the BV060 or 1.4 hours for the BB150.

Optional Accessories

CRF81 RF Output Adapter

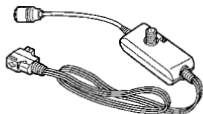

This adapter is used to connect your camcorder to a standard TV (one without audio/video input jacks) for playback. If your antenna cable is the flat twin-lead type attached by two screws, you will also need a 300-75 ohm transformer, such as 193983. If your TV has 300-ohm VHF screw terminals, you will need an optional 75-300 ohm transformer, such as AH011.

VAA009 Audio/Video Input Cable

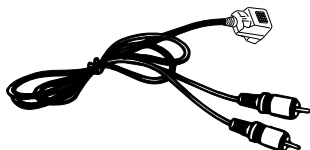

This audio/video input cable will enable you to use your camcorder to record from other devices which have audio/video output jacks (such as another VCR, camcorder, or TV monitor). This makes it convenient to copy tapes or record a television broadcast. The VAA009's plug is specially designed so other cables and accessories can be plugged into the camcorder at the same time.

AH25 Y-Adapter



This Y-adapter allows you to connect your camcorder's mono audio cable to a stereo TV or VCR.

AVS80 Synchro Edit Cable



This cable attaches to the camcorder to provide video and audio outputs for dubbing, or for direct input to a monitor receiver. It can also control the start/stop functions of a VCR with a compatible 2.5mm *PAUSE*, *EDIT*, *EDIT IN*, *EDIT IN/OUT*, or *SYNC* jack when copying a tape.

193983 Cable Transformer

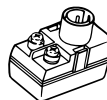

The 193983 is used to connect a standard 300-ohm antenna twin-lead to a standard round 75-ohm connector on the RF output adapter, a VCR, or TV.

AH011 Cable Transformer

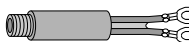

The AH011 is used to connect a standard round 75-ohm antenna cable to the 300-ohm screw terminals on a TV.

All specifications and descriptions of accessories are subject to change without notice.

Optional Accessories

AC088 Super Lightweight Tripod

Mounting the camcorder on a tripod, such as AC088, will keep the camcorder steady and produce excellent video results.

This tripod's fluid-effect head provides smooth camera pan and tilt. The quick-release mount makes it easy to attach or remove the camcorder. The grooved, tubular 3-section leg design folds down to 26" when not in use. Rubber feet allow for sure footing.

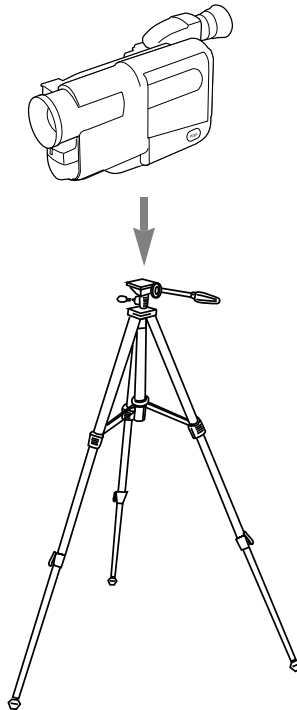

Cautions: Before using a tripod, make sure it is stable enough to hold the camcorder without falling over. Do not transport camcorder attached to tripod.

When attaching your camcorder to a tripod, be careful not to force the tripod screw into the camcorder's tripod mounting hole.

The tripod screw should not protrude into the camcorder more than approximately three-eighth (3/8) inch. Forcing the screw could damage the mounting hole on the bottom of the camcorder.

Accessory Order Form

Order Form for Camcorder Model Pro846

Description	Part No.	Price	Qty.	Total
Soft Camcorder Case	AC025A	\$ 59.95		
Super Lightweight Tripod	AC088	\$ 39.95		
75-300 Cable Transformer	AH011	\$ 1.90		
Y-Adapter	AH25	\$ 1.95		
Synchro Edit Cable	AVS80	\$ 54.95		
Rechargeable Battery	BB150	\$ 79.95		
Rechargeable Battery	BV060	\$ 59.95		
AC Battery Charger	CPS85	\$ 84.95		
RF Output Adapter	CRF81	\$ 49.95		
Car Cord Adapter	DCC06	\$ 74.95		
Car Adapter/Charger	DCC80	\$169.95		
Audio/Video Input Cable	VAA009	\$ 29.95		
Video Color Control Center	VCC1000	\$349.00		
Color Enhancement Light	VLP04	\$ 49.95		
Replacement Bulb for Light	VLB04	\$ 14.95		
300-75 Cable Transformer	193983	\$ 6.95		
Shoulder Strap	215770	\$ 13.95		
Audio/Video Cable	221357	\$ 24.95		
AC Adapter/Charger	221361	\$189.95		
Replacement Remote	221363	\$ 49.95		
DC Cable	221364	\$ 12.95		

Prices are subject to change without notice.

Total Merchandise (\$10 Minimum Order).....\$ _____

Sales Tax\$ _____

We are required by law to collect the appropriate sales tax for each individual state, county, and locality to which the merchandise is being sent.

Shipping, Handling, and Insurance\$ 5.00

Total Amount Enclosed\$ _____

Use VISA or MasterCard preferably. Money order or check must be in U.S. currency only. No COD or cash.

Detach Here 

Please complete other side also 

Accessory Order Form

Charge your order on your VISA
or MasterCard by
filling in below

USE YOUR CREDIT CARD

IMPORTANT: Copy complete account number
from your VISA card



My card expires:

IMPORTANT: Copy complete account number
from your MasterCard



Copy Number My card expires:
above your
name on
MasterCard

AUTHORIZED SIGNATURE

Prices are subject to change without notice.



Print or type your name and
address clearly. This will be
your mailing label.

A complete and correct
order will save you days
of waiting.

Name: _____

Street: _____

_____ Apt: _____

City: _____

State: _____ Zip: _____

Please make sure that both sides of this form
have been filled out completely.

- Allow 8 weeks for delivery.
- All accessories are subject to availability.
- Where applicable, we will ship a superseding model.

Detach Here 

Accessory Order Form

To order accessories, contact your local Dealer.

If a dealer is not nearby, you can also follow the directions below to order by telephone or direct-by-mail.

United States and Canada Orders

To place your order by phone, have your Visa or MasterCard ready and call the toll-free number listed below between 8AM and 8PM Eastern Standard Time. **Use this number only to place an order for accessory items listed on this order form.**

1 – 800 – 338 – 0376

Most times your order will be shipped UPS within 72 hours of receipt. If ever it is not possible to ship within 30 days, we will notify you with an update on your order and an option to cancel.

To place your order by mail, detach and mail the completed order form with credit card information, money order, or check in U.S. currency (made payable to Thomson Consumer Electronics, Inc.) to the following address:

Video Accessories
PO Box 8419
Ronks, PA 17573

For more information on these accessories (or current prices), write to the following address:

Video Accessories Customer Service
Thomson Consumer Electronics, Inc.
Distributor & Special Products
2000 Clements Bridge Rd
Deptford, NJ 08096-2088

International Orders

This offer is valid only in the United States and Canada. For international orders, please send your request for a price quotation (not an order) to:

International Customer Service
Thomson Consumer Electronics, Inc.
Distributor & Special Products
2000 Clements Bridge Rd
Deptford, NJ USA 08096-2088

Trouble Checks

Troubles sometimes are caused by simple “faults” that you can easily correct without the help of a service technician by first checking a few basic remedies.

Before you call or take your camcorder to an Authorized RCA Compact Camcorder Servicenter, look below for the type of trouble you are experiencing. Then perform the simple checks and adjustments listed for that trouble.

Trouble	Checks and Adjustments
No power	<ul style="list-style-type: none"> • If using battery, it may need to be recharged. • If using AC adapter/charger, make sure it is plugged into a working outlet.
Won't record or playback	<ul style="list-style-type: none"> • If using AC adapter/charger, make sure it is plugged into a working outlet. • There may be no cassette in the camcorder. • Try ejecting and reinserting the cassette. • The cassette tape may be broken, try another cassette. • You may have reached the end of the cassette, try rewinding it.
Won't playback	<ul style="list-style-type: none"> • <i>CAM/OFF/VCR</i> switch must be in <i>VCR</i>.
Won't record	<ul style="list-style-type: none"> • Safety tab has been closed. (<i>See page 20.</i>) • <i>CAM/OFF/VCR</i> switch must be in <i>CAM</i>.
No picture in viewfinder	<ul style="list-style-type: none"> • Remove lens cap. • <i>CAM/OFF/VCR</i> switch must be in <i>CAM</i>.
Tape stops during rewind or fast forward	<ul style="list-style-type: none"> • Time-counter memory may be on. Whenever an “<i>M</i>” appears with the time-counter display, the camcorder will stop rewinding (or fast forwarding) when counter reads “<i>0:00:00M</i>”. Press the <i>REW</i> or <i>F.F</i> button again to continue rewinding or fast forwarding, or press <i>DISPLAY</i> on remote to turn off memory-stop feature.
Rewind, fast forward, or play does not operate	<ul style="list-style-type: none"> • Make sure titler does not appear in viewfinder. Press <i>TITLE ON/OFF</i> on remote to remove titler. • Make sure the flashing cursor does not appear in the date or time display. Press <i>DATE/TITLE</i> to remove the flashing cursor and start the clock.
Camcorder remains in “stop action”	<ul style="list-style-type: none"> • Press thumb trigger (<i>PAUSE/RECORD</i> on remote) to return to normal playback.

Trouble Checks

Trouble	Checks and Adjustments
Poor auto-focus operation	<ul style="list-style-type: none"> • Make sure <i>FOCUS</i> does not appear in viewfinder. Press <i>FOCUS F</i> and <i>N</i> buttons together to turn on auto focus. See pages 32-33. • Scene is dark. Auto-focus may not work under this condition. See pages 32-33 for details on manual focus. • Lens is smudged, and image appears unfocused. • Viewfinder eyepiece focus is misadjusted. See page 29.
Viewfinder displays are out of focus	<ul style="list-style-type: none"> • Try adjusting eyepiece focus control. See page 29.
Date and/time, date, or date and title were recorded on tape	<ul style="list-style-type: none"> • Date and time or date will be recorded on tape whenever they appear in the viewfinder. Press <i>DATE/TITLE</i> button to remove them from viewfinder when recording. • Auto date or auto title feature turned on. See page 27.
Date and/or time are incorrect	<ul style="list-style-type: none"> • Camcorder's internal battery may need replacing. See page 28. • Date and/or time may need to be set. See page 26.
Remote control will not operate camcorder	<ul style="list-style-type: none"> • Aim remote at remote sensor on camcorder. • Remote must be within 13 feet from the camcorder to operate it. • Remote control cell may need replacing. See page 9. • <i>CAM/OFF/VCR</i> switch must be in <i>CAM</i> or <i>VCR</i> for camcorder to operate. • Camcorder's remote control sensor is exposed to direct sunlight or strong artificial light. This may interfere with operation of camcorder by remote.
Camcorder will not record from audio/video connector	<ul style="list-style-type: none"> • <i>CAM/OFF/VCR</i> switch must be in <i>CAM</i>. • Check cable connections and make sure other component is playing. See pages 42-43.
Camcorder turns off during operation	<ul style="list-style-type: none"> • Camcorder remained in pause for five minutes. Turn camcorder back on. • Rechargeable battery needs recharging or alkaline batteries need replacing.
Recorded audio too low	<ul style="list-style-type: none"> • Subject too far from camcorder.

Specifications

General

Power requirement: 6VDC
Power consumption: 5.3 W (when
FOCUS indicator appears in viewfinder)
Weight: 1.87 lbs. (without battery pack,
lens hood, lens cap, and cassette)
Dimensions: 3-11/16" (W) x 4-3/4"
(H) x 8-5/16" (D) (94 x 120 x 211mm)

Camera Section

Scanning: 525 Lines/60 Fields/30 Frames
Required Minimum Illumination: 1 lux
Lens: F/1.6 12:1 (4-48mm)
Image Sensor: 1/4" CCD
Diameter: 46 mm

Video Recorder Section

Format: 8mm
Record/Playback System:
Two video record/playback heads
One flying erase head

Video Signal: EIA Standard NTSC Color
Tape Speed: 14.3 mm/sec.
Video Input: 1.0 Vp-p, 75 ohm
Video Output: 1.0 Vp-p, 75 ohm
Audio Input: -7.8 dBs (316 m Vms)
Audio Output: -7.8 dBs (316 m Vms)
Fast Forward/Rewind Time: Less than
eight minutes with P6-120 cassette.

Tripod Mount

One 1/4" x 20 threaded hole

AC Adapter/Charger

Power requirement: 100-240 Volts,
50-60 Hz.
Power consumption: 20 W (Max)
Weight: 12 Ounces (330 grams)
Dimensions: 2-13/16" (W) x 1-11/16" (H)
x 5-15/16" (D) (72 x 43 x 151 mm)

User Information

This equipment has been tested and found to comply with the limits for a Class B digital device, and RF lighting device, pursuant to Part 15 and 18 of the FCC Rules. These limits are designed to provide reasonable protection against harmful interference in a residential installation. This equipment generates, uses, and can radiate radio frequency energy and, if not installed and used in accordance with the instructions, may cause harmful interference to radio communications. However, there is no guarantee that interference will not occur in a particular installation. If this equipment does cause harmful interference to radio or television reception, which can be determined by turning the equipment off and on, the user is encouraged to try to correct the interference by one or more of the following measures:

- Reorient or relocate the receiving antenna.
- Increase the separation between the equipment and receiver.
- Connect the equipment into an outlet on a circuit different from that to which the receiver is connected.

- Consult the dealer or an experienced radio/TV technician for help.

This device complies with Part 15 of the FCC Rules. Operation is subject to the following two conditions:

(1) This device may not cause harmful interference, and (2) this device must accept any interference received, including interference that may cause undesired operation.

Changes or modifications not expressly approved by Thomson Consumer Electronics, Inc. may void the user's FCC authority to operate this camcorder.

This digital apparatus does not exceed the Class B limits for radio noise emissions from digital apparatus as set out in the interference-causing equipment standard entitled "Digital Apparatus", ICES-003 of the Department of Communications.

Cet appareil numérique respecte les limites de bruits radioélectriques applicables aux appareils numériques de Classe B prescrites dans la norme sur le matériel brouilleur: "Appareils Numériques", NMB-003 édictée par le ministre des Communications.

Customer Assistance and Service

You can reach Thomson at the following number:

800-283-6503

(Toll free inside U.S.A.)

Our toll-free Camcorder number operates from 8 a.m. to 5 p.m., CST Monday – Friday for U.S. customers only

Thomson provides a toll-free telephone number to help you with any problems you may encounter with your camcorder. Many can be diagnosed over the phone, and if necessary, a replacement unit can be shipped to you. Please have your camcorder model/serial number and date of purchase ready when you call. If your unit is out of warranty, we will quote the cost of an exchange unit to you.

Returning equipment to Thomson for repair or exchange

If we are unable to resolve your problem over the phone, we will gladly service your unit or exchange it for a new or refurbished camcorder. Refer to the limited warranty on the reverse side to learn about your specific rights and responsibilities.

Always consult Thomson and get a Return Authorization number before returning anything! Obtain a Return Authorization (RA) number from the telephone representative before returning your equipment to avoid delays, accounting errors, or even loss of your unit.

Important information to customers who ship defective equipment to Thomson Consumer Electronics

The Thomson representative who authorized the return of your equipment will give you an RA number over the phone. They will also provide you with instructions on where and how to return your camcorder. Write the number in large, clear characters on the outside of the box. To avoid confusion and misunderstandings, shipments without an RA number clearly visible on the outside of the box will be returned to you at your expense.

Include a brief note describing the problem and any conversations about the problem you have had with Thomson personnel. Include your name, address

and model/serial number of your camcorder. These numbers are located on the bottom of your unit. If your camcorder is within the warranty period, please provide a copy of the bill of sale to verify purchase date. Use the original box and packing material to protect the equipment from damage in shipment.

For your protection, insure all shipments for full replacement value and use a reliable shipper. Thomson assumes no responsibility for warranty shipments from the customer to the factory if not shipped in the manner prescribed by Thomson.

(continued on next page)

Limited Warranty

What your warranty covers:

- Any defect in materials or workmanship.

For how long after your purchase:

- 90 days for labor charges.
- One year for parts.

What we will do:

During the initial 90 days

- Exchange your camcorder with a new or, at our option, a refurbished unit or at your option, repair your camcorder at no cost to you.

After the 90 days and within one year

- Exchange your camcorder with a new or, at our option, a refurbished unit or at your option, repair your camcorder. Parts will be provided at no charge, but you will be responsible for the cost of labor required for the repair.

How you get service:

- Call 1-800-283-6503 and have your unit's date of purchase and model/serial number ready. The model/serial number information is on the bottom of your camcorder.
- A representative will troubleshoot your problem over the phone. If the representative determines that you should receive a replacement unit, you will be provided with a Return Authorization (RA) number and the location of a nearby exchange point if one exists. No returns will be accepted without the RA number.

To receive a replacement camcorder before you return yours:

If you are located near an exchange point:

1. We will send a replacement unit to the exchange point next business day delivery.
2. The exchange location will notify you of its arrival.
3. Take your unit, including all accessories, and your bill of sale

which validates date of purchase to the exchange location and you will be provided the new or refurbished unit.

4. If the repairs were covered by your warranty, you will not be billed.

If you are *not* located near an exchange point:

1. Provide your Discover, MasterCard or Visa account number and expiration date to our phone representative. This is for security purposes. If we receive your unit including all accessories within 14 days from the date you were provided a Return Authorization number, only items not covered by warranty will be charged to your account. **IF YOUR UNIT INCLUDING ALL ACCESSORIES IS NOT RECEIVED WITHIN 14 DAYS, THE SUGGESTED RETAIL VALUE OF THE CAMCORDER AND/OR ACCESSORIES WILL BE CHARGED TO YOUR CREDIT CARD.** This amount will be credited if the unit is subsequently received.
2. We will send you a replacement unit next business day delivery.
3. You will receive an invoice packed with the replacement product, but will not be charged for the unit portion of the invoice amount if we receive your unit including all accessories within 14 days from the date you were provided the RA number. Any labor and parts charges not covered by our warranty will be included and charged against your account.
4. Ship the unit back to us along with all accessories included with your camcorder using the replacement unit's carton. Shipping instructions will be included in the carton along with your RA number, which will allow you to easily ship the unit back to us. **Make sure you insure your**

Limited Warranty

shipment in case of damage or loss.

Include with the shipment:

- A copy of your dated bill of sale to verify your unit's warranty eligibility.
- A brief note describing your camcorder problem.
- Your name, address and phone number.

Return transportation, storage, and handling costs and insurance are your sole responsibility. We accept no liability in case of damage or loss.

To receive a replacement unit after we have received your unit:

1. Write the RA number on the outside of the carton used to return the unit.

Make sure you insure your shipment in case of damage or loss.

2. Carefully pack the unit along with all accessories included with your camcorder, using the original box and packing material if possible.
3. Include with the shipment:
 - A copy of your dated bill of sale to verify your unit's warranty eligibility.
 - A brief note describing your camcorder problem.
 - Your name, address and phone number.

Return transportation, storage, and handling costs, and insurance are your responsibility. We accept no liability in case of damage or loss.

4. Include a cashier's check or money order for payment if there are any out of warranty labor or parts charges which were indicated by the representative, and you elected not to use your credit card.
5. Upon receipt of your product, a new or refurbished unit will be shipped to you next day delivery.

To have your Camcorder repaired by an Authorized RCA Camcorder Servicenter:

- Check with your dealer or call 1-800-336-1900 for the Authorized RCA Camcorder Servicenter nearest you.
- Take your unit to the Authorized RCA Camcorder Servicenter of your choice.
- Show the Authorized RCA Camcorder Servicenter representative your sales receipt or other, evidence of purchase.
- Pick up your camcorder when repairs are complete.

What your warranty does not cover:

- Adjustment of customer controls.
- Damage from misuse or neglect.
- A unit that has been modified or incorporated into other products or is used for institutional or other commercial purposes.
- Battery for clock and other features.
- Cleaning of video/audio heads.
- Camcorders purchased or serviced outside the U.S.A.
- Return transportation, storage and handling costs of your unit, including insurance for loss or damage.
- Acts of God, such as but not limited to lightning damage.

Product Registration:

- Please complete and mail the *Product Registration Card* packed with your camcorder. It will make it easier to contact you should it ever be necessary. The return of the card is not required for warranty coverage.

How State Law relates to warranty:

- This warranty gives you specific legal rights and you may have other rights that vary from state to state.

If you purchased your Camcorder outside the United States:

- This warranty does not apply. Contact your dealer for warranty information.

Index

- A/V (Audio/Video) *DUB*
 - Button 10-11,39
- A/V *DUB* Indicator 30,39
- Accessories, Included 3
- Accessories, Optional 55-61
- Accessory Shoe 8
- Accessory, Order Form 59-61
- Adapter/Charger, Using 4,12
- AE Shutter Speed Displays 24,30
- Alkaline Batteries, Using to
 - Power 16-17
- Assistance 1,3,65,Back Cover
- Attaching the Shoulder Strap 46
- Audio/Video Dubbing 38-39
- Audio/Video In/Out
 - Connector 8,38,40,42,52
- Audio/Video Jacks 8,50-51
- Auto Date and Title Features 27
- Auto Focus 32
- AUTO* Indicator 27
- Batteries, Alkaline Using 16-17
- Battery Level Indicator 17,30-31
- Battery Marker Switch 13
- Battery Safety Precautions 15,17
- Battery, Care and Storage 15
- Battery, Clock 28
- Battery, Inserting
 - Rechargeable 14
- Battery, Remote 9
- Battery, Using Rechargeable 13-15
- BRIGHT* Control 7,29
- Buttons, Remote 10-11
- CAM/OFF/VCR* Switch 5,7,8,
. 10-11,12,14,16,18-9,20,23
. 25,26,35,39,40-41,43,48,51,53
- Camcorder Operating Controls 7-8
- Camcorder, Powering 12-19
- Camcorder, Turning On 5
- Camcorder, Unpacking 3
- Car Cord Adapter, Optional 18,56
- Car Cord Adapter/Charger,
 - Optional 19,56
- Care and Maintenance 54
- Care and Storage of Battery 15
- Cassette Compartment 5,7
- Cassettes, Inserting and
 - Removing 21
- Charging the Battery 13
- Chart of Title Characters 37
- Checking Problems 62-63
- Cleaning the Viewfinder 54
- Clock Cell, Installing 28
- COLOR* Control 7,29
- Color Enhancement Light,
 - Optional 44-45,55
- Contents 1-2
- Copying Tapes 42-43,50-51
- Creating a Title 36
- Customer Assistance 65
- Date and Time Display 26-28
- Date and Time, Recording 27
- Date and Time, Setting 26
- Date Search Feature 25
- DATE/TITLE*
 - Button 7,26,27,31,36-37
- DC Car Cords, Optional 18-19,56
- DC IN 6V* Jack 8,12,18-19
- Design Specifications 64
- DISPLAY* Button 7,10-11,25,30,35
- Displays in Viewfinder 30-31
- Dubbing, Audio and Video 38-39
- EDIT SEARCH* Buttons 7,22,23
- Edit Search Feature 23
- EJECT* Switch 4,7,21
- Erase Protection 20
- Eyepiece Focus Control 6,7,29
- F.F* and *F.FWD* (Fast Forward)
 - Buttons 7,10-11
. 23,25,26,36-37,48-49
- First-Time Operation 3-8
- Flying Erase Head 22
- FOCUS F* and *N*
 - Buttons 7,30-31,32-33
- FOCUS* Indicator 30-31,32-33
- Focusing 32-33
- Hand Strap 5,8
- Holding the Camcorder 47
- I.ZOOM* Indicator 30,34
- Included Accessories 3
- Inserting and Removing
 - Cassettes 21
- INST. ZOOM* Button 8,30,34
- Lens 8
- Lens Cap, Attaching 5
- Lens Hood, Removing 46
- Light, Optional 44-45,55
- Limited Warranty 66-67
- Macro Focus 33
- Maintenance and Care 54
- Making Better Videos 47
- Manual Focus 33
- Memory-Stop Feature 35

Index

- Microphone7,22
- NO TAPE* Display30-31
- OPEN* Lever14,16
- Operating Controls, Camcorder7-8
- Operation, First-Time3-8
- Optional Accessories55-61
- Order Form, Accessory59-61
- Pause Indicator30
- PAUSE/RECORD* Button10-11
.....36-37,39,40-41,43,49,51,53
- Pause, Stop-Action49
- PLAY* Button7,10-11,23
.....36-37,39,40-41,43,48,51,53
- Playback Features49
- Playback on a TV With
 - AUDIO/VIDEO IN* Jacks50-51
- Playback on a TV Without
 - Audio/Video Inputs52-53
- Playback, Viewfinder48
- Plug Adapter12
- Power Zoom Buttons8,34
- Powering the Camcorder12-19
- Problem Solving62-63
- Product Registration
.....Inside Front Cover
- Program AE (Auto Exposure)
 - Feature24
- Quick Review22
- REC* Indicator6,30
- Recording from VCR or TV
 - Monitor42-43
- Recording Speed20
- Recording Tips47
- Recording Titles36
- Refreshing the Battery13
- Registration Card
.....Inside Front Cover
- Remote Battery9
- Remote Buttons10-11
- Remote Control9-11
- Remote Control Sensor8,9
- Removing Lens Hood46
- RESET* Button10-11,35
- REW* (Rewind) Buttons
.....7,10,22,23,35,36-37,48-49
- RF Output Adapter,
 - Optional52-53,57
- S. (Synchro) *EDIT* Button10-11,41
- Safety Tab20
- SEARCH* Indicator25
- Searching, Visual49
- Sensor, Remote Control8,9
- Setting the Time and Date26
- Shoulder Strap Attachment
 - Rings7,46
- Shoulder Strap, Attaching46
- Shutter Speeds24
- Solving Problems62-63
- Specifications64
- Speed, Recording and Playback20
- Status Indicators30
- STOP* Button7,10-11,23,25,26
.....35,36-37,39,40-41,48,49,51,53
- Stop-Action Pause49
- Synchro Edit40-41
- Tally Light8,22
- TAPE* Display30-31
- TAPE END* Display30-31
- Tape Copying42-43,50-51
- Tape Positioning23
- Thumb Trigger6,36-37,49
- Tilt Adjustment29
- Time and Date Display26-28
- Time and Date, Recording27
- Time and Date, Setting26
- Time Counter with Memory Stop
 - Feature30,35
- Time-Remaining Display24,30-31
- TINT* Control7,29
- Tips, Recording47
- Tips, Traveling47
- TITLE* Indicator27
- TITLE ON/OFF* Button10-11,36-37
- Title Character Chart37
- Titler36-37
- Traveling Tips47
- Tripod, Using58
- Trouble Checks62-63
- Turning On the Camcorder5
- Unpacking the Camcorder3
- Video Cassettes20-21
- Video/Audio Dubbing38-39
- Viewfinder6,7,29,30-31,48,54
- Visual Searching49
- Warranty, Limited66-67
- ZOOM* Buttons10-11,32-33,34
- ZOOM* Indicator30,34
- Zoom Level Indicator30,34
- Zooming34

Need Assistance? We want to help!

U.S. Consumers:

Camcorder Exchange Warranty800-283-6503

Customer Service800-336-1900

Accessories800-338-0376

Canadian Consumers:

English800-522-0338

French800-522-0445

If your camcorder needs service, please contact your dealer or the nearest Servicenter from the yellow pages. Please do not send any products to the Indianapolis address listed in this manual or on the carton. This will only add delays in service for your product.

 **THOMSON CONSUMER ELECTRONICS**
10330 North Meridian Street
Indianapolis, IN 46290

©1995 Thomson Consumer Electronics, Inc.

Trademark(s)[®] Registered

Marca(s) Registrada(s)

Printed in Japan

Part Number 95-Pro846-1

QR12994